

Pioneer *sound.vision.soul*

DVD/CD Receiver

XV-HTD340

Speaker System

S-HTD340

Register your product at:

www.pioneerelectronics.com

• **Protect your new investment**

The details of your purchase will be on file for reference in the event of an insurance claim such as loss or theft.

• **Receive free tips, updates and service bulletins on your new product**

• **Improve product development**

Your input helps us continue to design products that meet your needs.

• **Receive a free Pioneer newsletter**

Registered customers can opt in to receive a monthly newsletter.



Operating Instructions



The lightning flash with arrowhead, within an equilateral triangle, is intended to alert the user to the presence of uninsulated "dangerous voltage" within the product's enclosure that may be of sufficient magnitude to constitute a risk of electric shock to persons.

CAUTION

**RISK OF ELECTRIC SHOCK
DO NOT OPEN**

CAUTION:

TO PREVENT THE RISK OF ELECTRIC SHOCK, DO NOT REMOVE COVER (OR BACK). NO USER-SERVICEABLE PARTS INSIDE. REFER SERVICING TO QUALIFIED SERVICE PERSONNEL.



The exclamation point within an equilateral triangle is intended to alert the user to the presence of important operating and maintenance (servicing) instructions in the literature accompanying the appliance.

D1-4-2-3_En

IMPORTANT NOTICE – THE SERIAL NUMBER FOR THIS EQUIPMENT IS LOCATED IN THE REAR. PLEASE WRITE THIS SERIAL NUMBER ON YOUR ENCLOSED WARRANTY CARD AND KEEP IN A SECURE AREA. THIS IS FOR YOUR SECURITY.

D1-4-2-6-1_En

NOTE: This equipment has been tested and found to comply with the limits for a Class B digital device, pursuant to Part 15 of the FCC Rules. These limits are designed to provide reasonable protection against harmful interference in a residential installation. This equipment generates, uses, and can radiate radio frequency energy and, if not installed and used in accordance with the instructions, may cause harmful interference to radio communications. However, there is no guarantee that interference will not occur in a particular installation. If this equipment does cause harmful interference to radio or television reception, which can be determined by turning the equipment off and on, the user is encouraged to try to correct the interference by one or more of the following measures:

- Reorient or relocate the receiving antenna.
- Increase the separation between the equipment and receiver.
- Connect the equipment into an outlet on a circuit different from that to which the receiver is connected.
- Consult the dealer or an experienced radio/TV technician for help.

D8-10-1-2_En

CAUTION – PREVENT ELECTRIC SHOCK DO NOT USE THIS (POLARIZED) PLUG WITH AN EXTENSION CORD, RECEPTACLE OR OTHER OUTLET UNLESS THE BLADES CAN BE FULLY INSERTED TO PREVENT BLADE EXPOSURE.

ATTENTION – POUR PREVENIR LES CHOCS ELECTRIQUES NE PAS UTILISER CETTE FICHE POLARISEE AVEC UN PROLONGATEUR UNE PRISE DE COURANT OU UNE AUTRE SORTIE DE COURANT, SAUF SI LES LAMES PEUVENT ETRE INSEREES A FOND SANS EN LAISSER AUCUNE PARTIE A DECOUVERT.

D2-4-4-1_EF

WARNING: Handling the cord on this product or cords associated with accessories sold with the product will expose you to lead, a chemical known to the State of California and other governmental entities to cause cancer and birth defects or other reproductive harm.

Wash hands after handling

D36-P4_En

WARNING – TO PREVENT FIRE OR SHOCK HAZARD, DO NOT EXPOSE THIS APPLIANCE TO RAIN OR MOISTURE.

D1-4-2-1_En

For U.S. and Australia Model



C67-7-3_En

IMPORTANT SAFETY INSTRUCTIONS

READ INSTRUCTIONS — All the safety and operating instructions should be read before the product is operated.

RETAIN INSTRUCTIONS — The safety and operating instructions should be retained for future reference.

HEED WARNINGS — All warnings on the product and in the operating instructions should be adhered to.

FOLLOW INSTRUCTIONS — All operating and use instructions should be followed.

CLEANING — The product should be cleaned only with a polishing cloth or a soft dry cloth. Never clean with furniture wax, benzene, insecticides or other volatile liquids since they may corrode the cabinet.

ATTACHMENTS — Do not use attachments not recommended by the product manufacturer as they may cause hazards.

WATER AND MOISTURE — Do not use this product near water — for example, near a bathtub, wash bowl, kitchen sink, or laundry tub; in a wet basement; or near a swimming pool; and the like.

ACCESSORIES — Do not place this product on an unstable cart, stand, tripod, bracket, or table. The product may fall, causing serious injury to a child or adult, and serious damage to the product. Use only with a cart, stand, tripod, bracket, or table recommended by the manufacturer, or sold with the product. Any mounting of the product should follow the manufacturer's instructions, and should use a mounting accessory recommended by the manufacturer.

CART — A product and cart combination should be moved with care. Quick stops, excessive force, and uneven surfaces may cause the product and cart combination to overturn.



VENTILATION — Slots and openings in the cabinet are provided for ventilation and to ensure reliable operation of the product and to protect it from overheating, and these openings must not be blocked or covered. The openings should never be blocked by placing the product on a bed, sofa, rug, or other similar surface. This product should not be placed in a built-in installation such as a bookcase or rack unless proper ventilation is provided or the manufacturer's instructions have been adhered to.

POWER SOURCES — This product should be operated only from the type of power source indicated on the marking label. If you are not sure of the type of power supply to your home, consult your product dealer or local power company.

LOCATION — The appliance should be installed in a stable location.

NONUSE PERIODS — The power cord of the appliance should be unplugged from the outlet when left un-used for a long period of time.

GROUNDING OR POLARIZATION

- If this product is equipped with a polarized alternating current line plug (a plug having one blade wider than the other), it will fit into the outlet only one way. This is a safety feature. If you are unable to insert the plug fully into the outlet, try reversing the plug. If the plug should still fail to fit, contact your electrician to replace your obsolete outlet. Do not defeat the safety purpose of the polarized plug.
- If this product is equipped with a three-wire grounding type plug, a plug having a third (grounding) pin, it will only fit into a grounding type power outlet. This is a safety feature. If you are unable to insert the plug into the outlet, contact your electrician to replace your obsolete outlet. Do not defeat the safety purpose of the grounding type plug.

POWER-CORD PROTECTION — Power-supply cords should be routed so that they are not likely to be walked on or pinched by items placed upon or against them, paying particular attention to cords at plugs, convenience receptacles, and the point where they exit from the product.

OUTDOOR ANTENNA GROUNDING — If an outside antenna or cable system is connected to the product, be sure the antenna or cable system is grounded so as to provide some protection against voltage surges and built-up static charges. Article 810 of the National Electrical Code, ANSI/NFPA 70, provides information with regard to proper grounding of the mast and supporting structure, grounding of the lead-in wire to an antenna discharge unit, size of grounding conductors, location of antenna-discharge unit, connection to grounding electrodes, and requirements for the grounding electrode. See Figure A.

LIGHTNING — For added protection for this product during a lightning storm, or when it is left unattended and unused for long periods of time, unplug it from the wall outlet and disconnect the antenna or cable system. This will prevent damage to the product due to lightning and power-line surges.

POWER LINES — An outside antenna system should not be located in the vicinity of overhead power lines or other electric light or power circuits, or where it can fall into such power lines or circuits. When installing an outside antenna system, extreme care should be taken to keep from touching such power lines or circuits as contact with them might be fatal.

OVERLOADING — Do not overload wall outlets, extension cords, or integral convenience receptacles as this can result in a risk of fire or electric shock.

OBJECT AND LIQUID ENTRY — Never push objects of any kind into this product through openings as they may touch dangerous voltage points or short-out parts that could result in a fire or electric shock. Never spill liquid of any kind on the product.

SERVICING — Do not attempt to service this product yourself as opening or removing covers may expose you to dangerous voltage or other hazards. Refer all servicing to qualified service personnel.

DAMAGE REQUIRING SERVICE — Unplug this product from the wall outlet and refer servicing to qualified service personnel under the following conditions:

- When the power-supply cord or plug is damaged.
- If liquid has been spilled, or objects have fallen into the product.
- If the product has been exposed to rain or water.
- If the product does not operate normally by following the operating instructions. Adjust only those controls that are covered by the operating instructions as an improper adjustment of other controls may result in damage and will often require extensive work by a qualified technician to restore the product to its normal operation.
- If the product has been dropped or damaged in any way.
- When the product exhibits a distinct change in performance — this indicates a need for service.

REPLACEMENT PARTS — When replacement parts are required, be sure the service technician has used replacement parts specified by the manufacturer or have the same characteristics as the original part. Unauthorized substitutions may result in fire, electric shock, or other hazards.

SAFETY CHECK — Upon completion of any service or repairs to this product, ask the service technician to perform safety checks to determine that the product is in proper operating condition.

WALL OR CEILING MOUNTING — The product should not be mounted to a wall or ceiling.

HEAT — The product should be situated away from heat sources such as radiators, heat registers, stoves, or other products (including amplifiers) that produce heat.

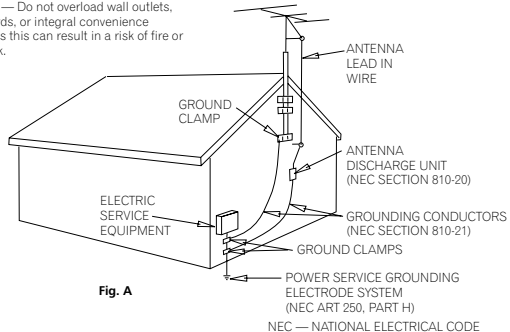

Fig. A

NEC — NATIONAL ELECTRICAL CODE

This Class B digital apparatus complies with Canadian ICES-003.

Cet appareil numérique de la Classe B est conforme à la norme NMB-003 du Canada.

D8-10-1-3_EF

Information to User

Alteration or modifications carried out without appropriate authorization may invalidate the user's right to operate the equipment.

D8-10-2_En

CAUTION : USE OF CONTROLS OR ADJUSTMENTS OR PERFORMANCE OF PROCEDURES OTHER THAN THOSE SPECIFIED HEREIN MAY RESULT IN HAZARDOUS RADIATION EXPOSURE.

CAUTION : THE USE OF OPTICAL INSTRUMENTS WITH THIS PRODUCT WILL INCREASE EYE HAZARD. D6-8-2-1_En

CAUTION

- Use of controls or adjustments or performance of procedures other than those specified herein may result in hazardous radiation exposure.
- The use of optical instruments with this product will increase eye hazard.

H013_En

Energy-saving design

This system is designed to use 0.5W of electricity when power is switched to standby.

This product is for general household purposes. Any failure due to use for other than household purposes (such as long-term use for business purposes in a restaurant or use in a car or ship) and which requires repair will be charged for even during the warranty period.

K041_En

This product incorporates copyright protection technology that is protected by method claims of certain U.S. patents and other intellectual property rights owned by Macrovision Corporation and other rights owners. Use of this copyright protection technology must be authorized by Macrovision Corporation, and is intended for home and other limited viewing uses only unless otherwise authorized by Macrovision Corporation. Reverse engineering or disassembly is prohibited.

Thank you for buying this Pioneer product.

Please read through these operating instructions so that you will know how to operate your model properly. After you have finished reading the instructions, put them in a safe place for future reference.

Contents

01 Before you start

Features	7
What's in the box	7
Putting the batteries in the remote control ..	7
Using the remote control	8
Disc / content format playback compatibility	8
CD-R/RW compatibility	8
DVD-R/RW compatibility	8
PC-created disc compatibility	9
Compressed audio compatibility	9
About WMA	9
JPEG file compatibility	9

02 Connecting up

Connecting the speakers	10
Placing the speakers	11
Wall-mounting the surround speaker system	13
Connecting to your TV	13
Connecting using the S-video output ..	14
Connecting using the component video output	14
Listening to TV audio through this system	16
Using this unit with a Pioneer plasma display	16
Using the SR+ mode with a Pioneer plasma display	17
Connecting the supplied antennas	18
Assembling the loop antenna	18
AM loop antenna	18
FM wire antenna	19
Connecting the power	19

03 Controls and displays

Front panel	20
Display	21

Remote control	23
----------------------	----

04 Getting started

Switching on and setting up	26
Setting the clock	27
Using the Room Setup	27
Setting up the remote to control your TV ..	28
Using the on-screen displays	29
Playing discs	29
Basic playback controls	30
Resume and Last Memory	31
Changing discs	32
DVD-Video disc menus	33
Video CD PBC menus	34
Listening to the radio	34
Improving poor FM reception	35
Memorizing stations	35
Listening to station presets	36
Listening to other sources	36

05 Listening to your system

About the listening modes	37
Auto listening mode	37
Listening in surround sound	38
Dolby Pro Logic II Music settings	38
Using the Advanced Surround effects	39
Using Front Surround	39
Adjusting the Advanced and Front Surround effect level	40
Listening in stereo	40
Listening with headphones	40
Enhancing dialogue	41
Listening with a virtual surround back speaker	41
Using Quiet and Midnight listening modes	41
Adjusting the bass and treble	42
Boosting the bass level	42

06 Playing discs

Playing only CDs and WMA/MP3 discs (CD mode)	43
Scanning discs	43
Playing in slow motion	43
Frame advance/frame reverse	44
Using the Disc Navigator to browse the contents of a disc	44
Looping a section of a disc	45
Using repeat play	45
Using random play	46
Creating and editing a DVD program list	47
Creating and editing a non-DVD program list	48
Other functions available from the program menu	50
Searching a disc	50
Switching subtitles	51
Switching DVD audio language	51
Switching audio channels when playing a Video CD	51
Zooming the screen	51
Switching camera angles	51
Displaying disc information	52

07 Viewing JPEG discs

Playing a JPEG slideshow	53
Using the JPEG Disc Navigator and Photo Browser	53
Zooming the screen	54

08 Using the timer

Setting the wake-up timer	55
Turning the wake-up timer on/off	56
Setting the sleep timer	56

09 Surround sound and other settings

Using the System Setup menu	58
Surround and sound setup options	58
SR+ control options for Pioneer plasma displays	59
Setting the channel levels	60

10 Video Adjust menu

Video Adjust	62
Creating your own presets	62

11 Initial Settings menu

Using the Initial Settings menu	63
Video Output settings	63
Language settings	64
Display settings	64
Options	65
Parental Lock	65

12 Additional information

Optional system settings	67
System Setup menu options in standby	67
Resetting the system	68
Using and taking care of discs	68
Titles, chapters and tracks	68
DVD Video regions	68
Handling discs	69
Storing discs	69
Discs to avoid	69
Proper installation and maintenance of this system	70
Hints on installation	70
Cleaning the pickup lens	70
Problems with condensation	70
Moving the system unit	70
Power cord caution	70
Connecting external antennas	71
Connecting auxiliary components	71
Recording mode	72
Troubleshooting	73
General	73
DVD/CD/Video CD player	74
WMA/MP3/JPEG discs	75
Tuner	75
Error Messages	76
Screen sizes and disc formats	77
Widescreen TV users	77
Standard TV users	77
Selecting languages using the language code list	77
Language code list	78
Country code list	78
Preset code list	79
Glossary	80
Specifications	81

Chapter 1

Before you start

Features

- **24-bit / 96kHz compatible DAC**

This system is fully compatible with high sampling-rate discs, capable of delivering exceptional sound quality in terms of dynamic range, low-level resolution and high-frequency detail.

- **Surround sound entertainment with Dolby Digital and DTS software**

The built-in Dolby Digital and DTS decoders let you enjoy great surround sound with Dolby Digital and DTS discs.

- **Pure Cinema progressive scan video**

When connected to a progressive scan-compatible TV or monitor using the component video outputs, you can enjoy extremely stable, flicker free images, with the same frame refresh rate as the original movie.

- **Picture zoom**

See *Zooming the screen* on page 51.

- **MP3 and WMA compatibility**

See *Compressed audio compatibility* on page 9.

- **JPEG compatibility**

See *JPEG file compatibility* on page 9.

- **Graphical on-screen displays**

Setting up and using your DVD home theater system is made easy using the graphical on-screen displays.

- **Energy saving design**

This system is designed to use 0.5 W of power when in standby.

What's in the box

Please confirm that the following accessories are in the main system box when you open it.

- Remote control
- AA/R6P dry cell batteries x2
- Video cable (yellow plugs)
- AM loop antenna
- FM wire antenna
- Power cord
- These operating instructions
- Warranty card

Please confirm that the following accessories are in the speaker box when you open it.

- Speaker cables x6
- Non-skid pads for speakers (1 sheet)

Putting the batteries in the remote control

- **Open the battery compartment cover and insert the batteries as shown.**

Use two AA/R6P batteries and follow the indications (⊕, ⊖) inside the compartment. Close the cover when you're finished.

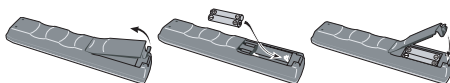

Important

Incorrect use of batteries can result in hazards such as leakage and bursting. Please observe the following:

- Don't mix new and old batteries together.

- Don't use different kinds of battery together—although they may look similar, different batteries may have different voltages.
- Make sure that the plus and minus ends of each battery match the indications in the battery compartment.
- Remove batteries from equipment that isn't going to be used for a month or more.
- When disposing of used batteries, please comply with governmental regulations or environmental public instruction's rules that apply in your country or area.

H048 En

Using the remote control

Keep in mind the following when using the remote control:

- Make sure that there are no obstacles between the remote and the remote sensor on the system unit.
- The remote has a range of about 23 ft. / 7 m at an angle of less than 30°.
- Remote operation may become unreliable if strong sunlight or fluorescent light is shining on the system unit's remote sensor.
- Remote controllers for different devices can interfere with each other. Avoid using remotes for other equipment located close to this system.
- Replace the batteries when you notice a fall off in the operating range of the remote.

Disc / content format playback compatibility

This player is compatible with a wide range of disc types (media) and formats. Playable discs will generally feature one of the following logos on the disc and/or disc packaging. Note

however that some disc types, such as recordable CD and DVD, may be in an unplayable format—see below for further compatibility information.



- KODAK Picture CD
-  is a trademark of Fuji Photo Film Co. Ltd.

CD-R/RW compatibility

- This system will play CD-R and CD-RW discs recorded in CD Audio or Video CD format, or as a CD-ROM containing MP3, WMA or JPEG files. However, any other content may cause the disc not to play, or create noise/distortion in the output.
- This system cannot record CD-R or CD-RW discs.
- Unfinalized CD-R/RW discs recorded as CD Audio can be played, but the full Table of Contents (playing time, etc.) will not be displayed.

DVD-R/RW compatibility

- Compatible formats: DVD-Video, Video Recording (VR)*
- * *Edit points may not play exactly as edited; screen may go momentarily blank at edited points.*
- Unfinalized playback: No

- WMA/MP3/JPEG file playback on DVD-R/RW: No

PC-created disc compatibility

Discs recorded using a personal computer may not be playable in this unit due to the setting of the application software used to create the disc. In these particular instances, check with the software publisher for more detailed information.

Discs recorded in packet write mode (UDF format) are not compatible with this player.

Check the DVD-R/RW or CD-R/RW software disc boxes for additional compatibility information.

Compressed audio compatibility

- Compatible formats: MPEG-1 Audio Layer 3 (MP3), Windows Media Audio (WMA)
- Sampling rates: 32, 44.1 or 48kHz
- Bit-rates: Any (128Kbps or higher recommended)
- VBR (variable bit rate) MP3 playback: Yes
- VBR WMA playback: No
- WMA lossless encoding compatible: No
- DRM (Digital Rights Management) compatible: Yes (DRM-protected audio files will *not* play in this player). See also DRM in the *Glossary* on page 80.
- File extensions: .mp3, .wma (these must be used for the player to recognize MP3 and WMA files – do not use for other file types)
- File structure: Up to 999 files per folder

About WMA



The Windows Media[®] logo printed on the box indicates that this player can playback Windows Media Audio content.

WMA is an acronym for Windows Media Audio and refers to an audio compression technology developed by Microsoft Corporation. WMA content can be encoded by using Windows Media[®] Player version 7, 7.1, Windows Media[®] Player for Windows[®] XP, or Windows Media[®] Player 9 Series.

Microsoft, Windows Media, and the Windows logo are trademarks, or registered trademarks of Microsoft Corporation in the United States and/or other countries.

JPEG file compatibility

- Compatible formats: Baseline JPEG and EXIF 2.1* still image files up to 8 megapixels are supported (maximum resolution is 5120 x 5120 pixels).
*File format used by digital still cameras
- File extensions: .jpg (must be used for the player to recognize JPEG files – do not use for other file types)
- File structure: Up to 999 files per folder

Chapter 2

Connecting up

Connecting the speakers

**Important**

- Before making or changing any rear panel connections, make sure that all the components are switched off and unplugged from the power supply.

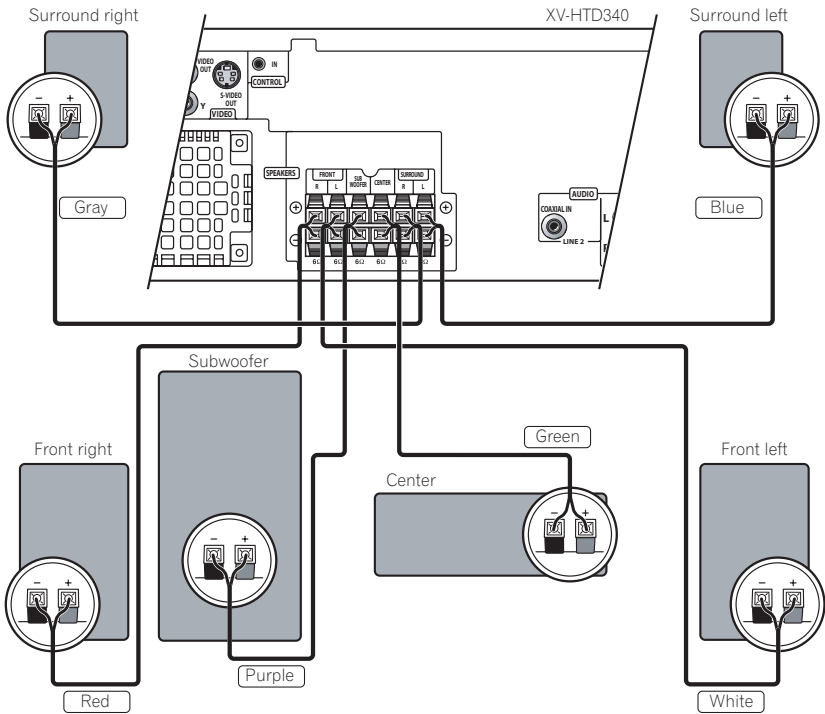

Connect each speaker using the color-coded speaker cable. Match them to the colored labels above the speaker terminals.



Caution

- These speaker terminals can be under **HAZARDOUS VOLTAGE**. When you connect or disconnect the speaker cables, to prevent the risk of electric shock, do not touch uninsulated parts before disconnecting the power cord.
- Do not connect any of the supplied speakers to any other amplifier. This may result in malfunction or fire. This system has been designed for best performance when connected to the supplied speakers. We do not, therefore, recommend that you connect and use other speakers with this system.

1 Twist and pull off the protective shields on each wire.



2 Connect to the speaker terminals on the rear of the system unit.

Match the colored wire with the color-coded label (above the tabs), then insert the colored wire into the red (+) tab and the other wire with the black (-) tab.

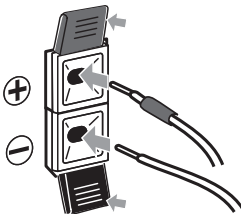

3 Connect to the speaker terminals on the rear of the speakers in the same way.

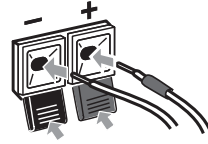

Note

- Remove the supplied non-skid pads from the paper, and stick four onto the base of each satellite speaker. Actual speakers supplied may differ from those shown.

Placing the speakers

Depending on the size and characteristics of your room, you can choose to place your speakers in one of two ways using this system:

- **Standard surround 5-spot setup** – This is a standard multichannel surround sound speaker setup for optimal 5.1 channel home theatre sound.

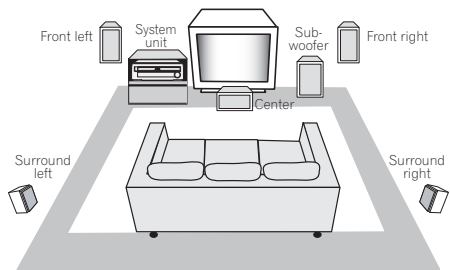

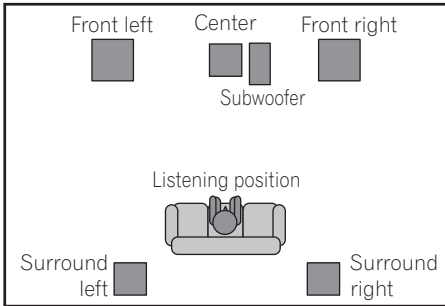

- **Front surround 3-spot setup** – This setup is ideal when rear surround speaker placement isn't possible or you want to avoid running long speaker cables in your listening area. Use this setup together with the Front Surround modes to take advantage of wall and ceiling reflections for a very realistic surround effect.

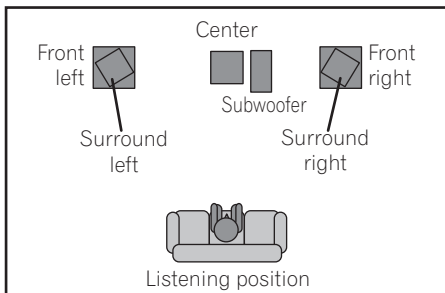
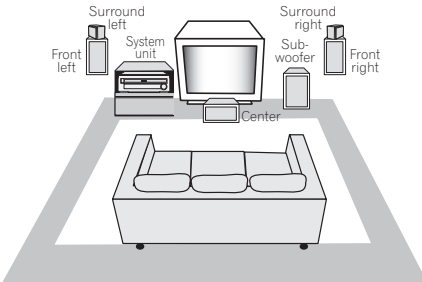

See *About the listening modes* on page 37 for more on using the different listening modes with each speaker setup.

Where you put your speakers in the room has a big effect on the quality of the sound. The following guidelines should help you to get the best sound from your system.

- The subwoofer can be placed on the floor. Ideally, the other speakers should be at about ear-level when you're listening to them. Putting the speakers on the floor (except the subwoofer), or mounting them very high on a wall is not recommended.
- For the best stereo effect, place the front speakers 6–9 ft. / 2–3 m apart, at equal distance from the TV.
- Install the center speaker above or below the TV so that the sound of the center channel is localized at the TV screen.
- When using a 5-spot setup, install the surround speakers slightly above ear level, if possible.



Caution

- Make sure that all speakers are securely installed (if you choose to install the center speaker on top of the TV, be sure to secure it by suitable means). This not only improves sound quality, but also reduces the risk of damage or injury resulting from speakers being knocked over or falling in the event of external shocks such as earthquakes.

Note

- The front, center and surround speakers supplied with this system are magnetically shielded. However, placing them extremely close to a television may result in color distortion on the screen. If this happens, move the speakers a little further away and switch off the television for 15–30 minutes.
- The subwoofer is not magnetically shielded and so should not be placed near a TV or monitor.

Wall-mounting the surround speaker system

Before mounting

- Remember that the speaker system is heavy and that its weight could cause the wood screws to work loose, or the wall material to fail to support it, resulting in the speaker falling. Make sure that the wall you intend to mount the speakers on is strong enough to support them. Do not mount on plywood or soft surface walls.
- Mounting screws are not supplied. Use screws that are suitable for the wall material and that will support the weight of the speaker.

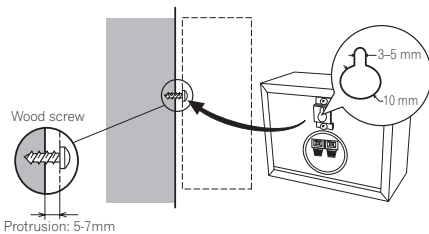

Note

- If you are unsure of the qualities and strength of the walls, consult a professional for advice.
- Pioneer is not responsible for any accidents or damage that result from improper installation.

Connecting to your TV

This system has three different kinds of video output that you can use to connect up your TV. Check the available inputs on your TV to see which you can use.

Important

- Do not connect a VCR between this system and your TV as DVD playback will be affected.
- **Use the supplied video cable to connect the VIDEO OUT jack to a video input on your TV.**

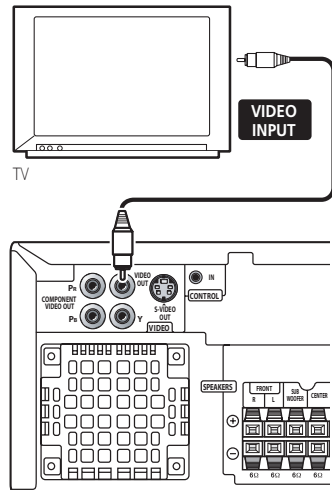

Note

- Placing the system unit too close to your TV may cause interference, especially if you're using an indoor antenna. If you notice interference, move the system unit away from the TV.

Connecting using the S-video output

If your TV has an S-video input, you can use this instead of the standard video output for a better quality picture.

- Use an S-video cable (not supplied) to connect the S-VIDEO OUT to an S-video input on your TV.

Line up the small triangle below the jack with the same mark on the plug before plugging in.

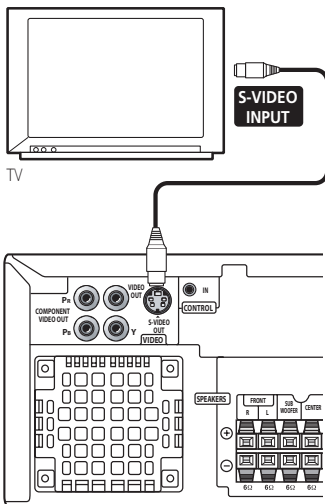

Note

- The S-video output is switchable between S1 and S2 formats for compatibility with all TVs. See *Video Output settings* on page 63 for more on this.

Connecting using the component video output

If your TV has component video inputs, you can use these instead of the standard video output to connect this system to your TV. This should give you the best quality picture from the three types of video output available.

- Use a component video cable (not supplied) to connect the COMPONENT VIDEO OUT to a set of component inputs on your TV.

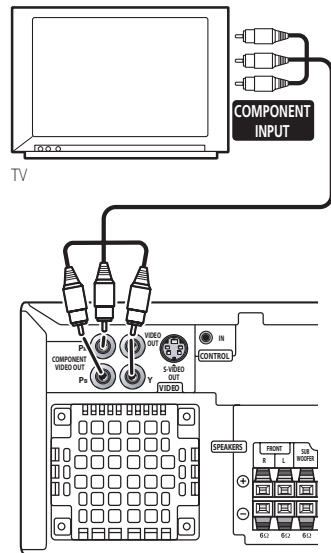

Note

- The component video output is switchable between interlaced and progressive formats. See *Video Output settings* on page 63 and *Watching progressive scan video from the component video outputs* below for more on this.

Watching progressive scan video from the component video outputs

Compared to interlace video, progressive scan video effectively doubles the scanning rate of the picture, resulting in a very stable, flicker-free image. Progressive scan video is available only from the component video output. There are a few things to keep in mind when switching the **Component Out** (page 63) setting to **Progressive**:

- When set to **Progressive**, there is no video output from the **VIDEO OUT** (composite) and **S** (S-video) jacks.
- If you want to display video on more than one monitor simultaneously, make sure the player is set to **Interlace**.
- If you connect a TV that is not compatible with a progressive scan signal and switch the setting to **Progressive**, you will not be able to see any picture at all. In this case, press **⏻ STANDBY/ON** to put the system in standby, then press and hold the front panel **■** (stop) button for about 8 seconds until the display shows **Mem.Clr.?** Press the front panel **◀◀◀** or **▶▶▶** button so that the display shows **Interlace?** Press the front panel **▶/||** button to set to interlace and switch the system back on.

Compatibility of this player with progressive-scan and high-definition TVs.

This player is compatible with progressive video Macro Vision System Copy Guard.

Consumers should note that not all high-definition television sets are fully compatible with this product and may cause artifacts to be displayed in the picture. In case of 525 progressive scan picture problems, it is recommended that the user switch the

connection to the 'standard definition' output (Interlace). If there are questions regarding our TV set compatibility with this model, please contact our customer service center.

This system is compatible with the following Pioneer displays and monitors:

Plasma display

PDP-505HD, PDP-5030HD, PDP-4330HD, PDP-5040HD, PDP-4340HD, PRO-10000HD, PRO-800HD, PRO-1000HDI, PRO-800HDI, PRO-1110HD, PRO-910HD, PDP-4300, PDP-5031

Projection monitor receiver

SD-533HD5, SD-643HD5, PRO-710HD, PRO-610HD, PRO-510HD, PRO-720HD, PRO-620HD, PRO-520HD, PRO-730HD, PRO-630HD, PRO-530HD, PRO-730HDI, PRO-530HDI

Listening to TV audio through this system

You can connect the audio output of your TV to this system so that broadcast TV sound is played through this system.

- **Connect a stereo audio cable (not supplied) from the audio outputs of your TV to the TV IN jacks on this system.**

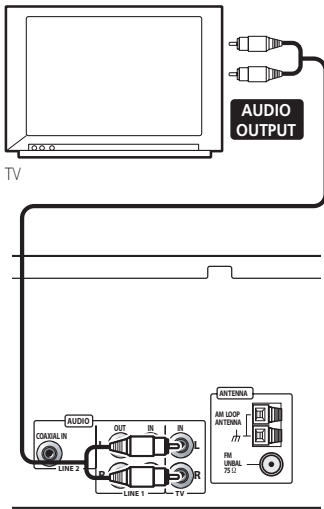

Tip

- If you find that the TV audio is distorting when played through this system, you can set the input attenuator to reduce the input signal level. See *Optional system settings* on page 67 to do this.

Using this unit with a Pioneer plasma display

If you have a Pioneer plasma display (models PRO-1110HD, PRO-910HD, PDP-5040HD, PDP-4340HD), you can use an SR+ cable (see note below) to connect it to this unit and take advantage of various convenient features, such as automatic video input switching of the plasma display when the input is changed.

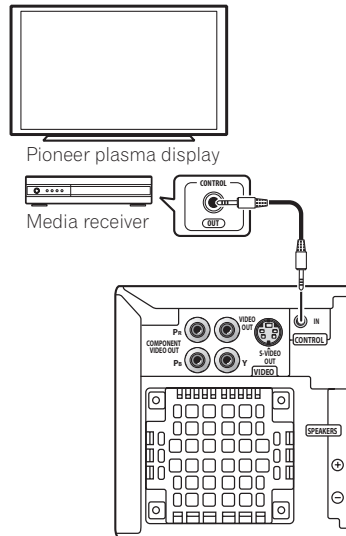

- **Use a 3-ringed miniplug SR+ cable to connect the CONTROL IN jack of this unit through a media receiver to the CONTROL OUT jack of your plasma display.**

Before you can use the extra SR+ features, you need to make a few settings in the unit. See *SR+ control options for Pioneer plasma displays* on page 59 for detailed instructions.

Using the SR+ mode with a Pioneer plasma display

When connected using an SR+ cable, a number of features (such as automatic video input switching and volume muting on the plasma display) become available to make using this unit with your Pioneer plasma display even easier.

See also *SR+ control options for Pioneer plasma displays* on page 59 for information on setting up the unit.

1 Make sure that the plasma display and this unit are switched on and that they are connected with an SR+ cable.

See *Using this unit with a Pioneer plasma display* above for more on connecting these components.

2 To switch SR+ mode on/off, press SR+ (SHIFT + 7).

The front panel display shows the new setting; **SR+ ON** or **SR+ OFF**.

- If **SR+ Error** shows in the display, it means there is a communication problem between the unit and the plasma display. Check all connections and retry.



Note

- The 3-ringed SR+ cable from Pioneer is commercially available under the part number ADE7095. Contact the Pioneer Customer Support division for more information on obtaining an SR+ cable.
- You won't be able to use the remote sensor of this unit with the **CONTROL IN** jack of this unit connected to the **CONTROL OUT** jack of your plasma display. You can use the remote sensor of the plasma display (even in standby) as long as the power isn't switched off.

- The automatic volume muting feature is enabled separately; see *SR+ control options for Pioneer plasma displays* on page 59. (You can also use the System Setup menu to switch the SR+ mode of this unit.)
- If you disconnect the SR+ cable or switch the plasma display off while SR+ is on, the setting automatically reverts to **SR+ OFF**. This displays an error if you switch the input of the unit with the plasma display switched off. Likewise, if this unit is switched off, the link with the plasma display will be terminated.

Connecting the supplied antennas

The supplied antennas provide a simple way to listen to AM and FM radio. If you find that reception quality is poor, an outdoor antenna should give you better sound quality—see *Connecting external antennas* on page 71 for more on how to do this.

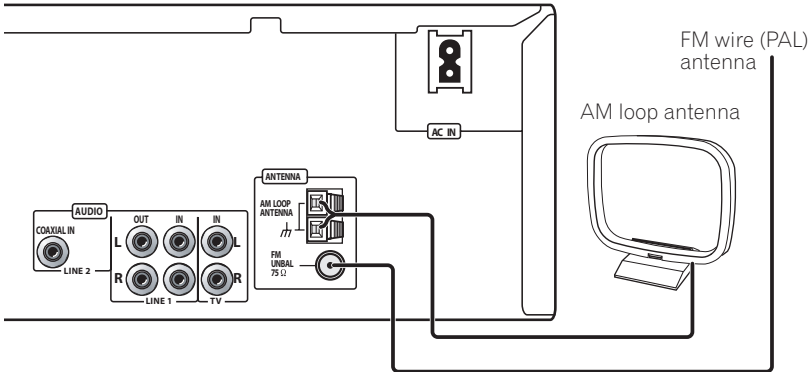

Assembling the loop antenna

1 Bend the stand in the direction indicated.

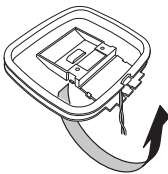

2 Clip the loop onto the stand.

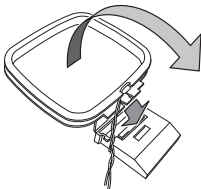

AM loop antenna

- 1** Pull off the protective shields of both AM antenna wires.
- 2** Press the antenna terminal tabs to open and insert one wire into each terminal.
- 3** Release the tabs to secure the AM antenna wires.
- 4** Place the AM antenna on a flat surface and point in the direction giving the best reception.

Avoid placing near computers, television sets or other electrical appliances and do not let it come into contact with metal objects.

 **Note**

- It's also possible to fix the AM antenna to a wall using two screws (see illustration below). Before fixing, make sure that the reception is satisfactory.

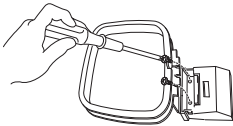

FM wire antenna

- **Connect the FM wire antenna to the FM UNBAL 75Ω terminal in the same way as the AM loop antenna.**

For best results, extend the FM antenna fully and fix to a wall or door frame. Don't drape loosely or leave coiled up.

 **Note**

- The signal ground (⚡) is designed to reduce noise that occurs when an antenna is connected. It is not an electrical safety ground.

Connecting the power

Before connecting the power and switching on for the first time make sure that everything is connected properly.

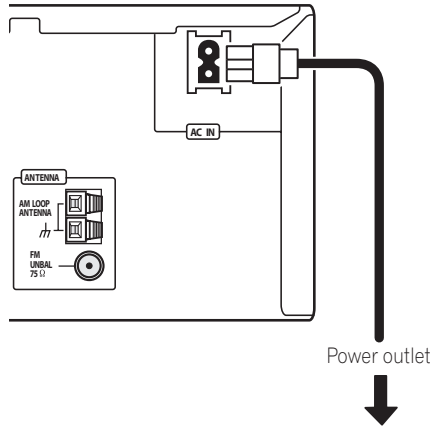

1 Plug one end of the supplied power cord into the AC INLET.

2 Plug the other end into a household power outlet.

 **Note**

- See *Connecting auxiliary components* on page 71 for details of other connections you can make with this system.

Chapter 3

Controls and displays

Front panel

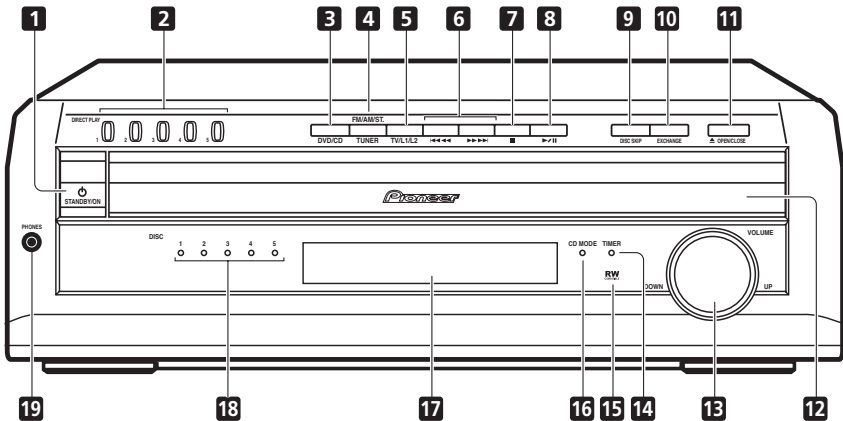

- 1 **⏻ STANDBY/ON** (page 26)
Press to switch the system on or into standby.
- 2 **DIRECT PLAY buttons** (page 30)
Press to start playback of any disc in the player.
- 3 **DVD/CD** (page 29)
Press to switch to the **DVD/CD** function. Also starts/pauses/resumes playback of the currently loaded disc.
- 4 **TUNER FM/AM/ST.** (page 34)
Press to switch to the tuner function, then between bands and station presets.
- 5 **TV/L1/L2** (page 36)
Press to switch between the external sources, **TV**, **LINE 1 (L1)** and **LINE 2 (L2)**.
- 6 **⏮⏮⏮ and ⏭⏭⏭**
Press to skip tracks/chapters; press and hold to scan backwards/forwards.
- 7 **■**
Press to stop playback.
- 8 **▶/⏸**
Press to start or resume playback. During playback, press to pause; press again to restart playback.
- 9 **DISC SKIP** (page 30, 32)
 - During playback, press to start playing the next disc in the player.
 - If the disc tray is open while no disc is playing, the tray rotates one disc space.
 - If the disc tray was opened using the **EXCHANGE** button, then pressing **DISC SKIP** rotates the disc tray two disc spaces.
- 10 **EXCHANGE**
Press to exchange the disc in the tray.
- 11 **OPEN/CLOSE**
Press to open or close the disc tray.
- 12 **VOLUME UP**
Press to increase the volume.
- 13 **VOLUME DOWN**
Press to decrease the volume.
- 14 **RW**
Press to repeat or shuffle playback.
- 15 **CD MODE**
Press to switch between CD and DVD playback.
- 16 **TIMER**
Press to set a timer for playback.
- 17 **Display window**
Shows the current track, chapter, and time.
- 18 **Disc tray**
Insert or remove discs here.
- 19 **PHONES**
Connect headphones for private listening.

10 EXCHANGE (page 32)

Press during playback to open the disc tray without stopping playback. Press again to close the disc tray.

11 ▲ OPEN/CLOSE

Press to open/close the disc tray.

12 Disc tray

13 VOLUME control

Use to adjust the volume.

14 Timer indicator (page 55)

Lights when the timer is set.

15 RW
COMPATIBLE

This mark indicates compatibility with DVD-RW discs recorded on a DVD recorder in Video Recording (VR) mode.

16 CD MODE indicator (page 43)

Lights when the CD Mode is on. In this mode, the system only plays audio CDs and WMA/MP3 discs.

17 Display

See *Display* on page 21 for detailed information.

18 DISC indicators

Shows which disc spaces are currently occupied.

19 PHONES jack

Headphone jack.

Display

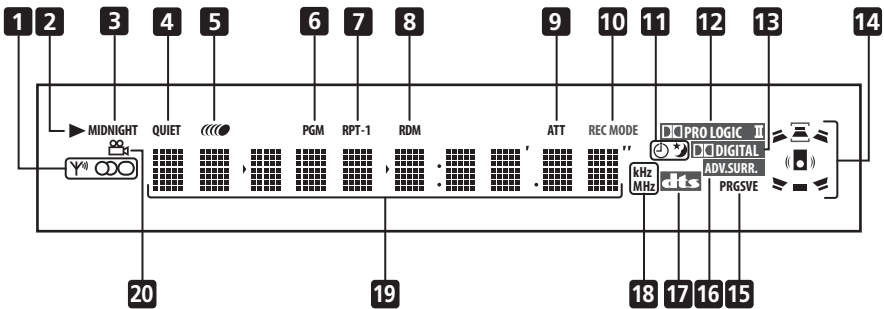

1 Tuner indicators (page 34)



Lights when a broadcast is being received.



Lights when a stereo FM broadcast is being received in auto stereo mode.



Lights when FM mono reception is selected.



Lights when a disc is playing.

3 MIDNIGHT (page 41)

Lights when the Midnight mode is selected.

4 QUIET (page 41)

Lights when the Quiet mode is selected.

5 

Lights to indicate random or repeat play of all discs loaded.

6 PGM (page 47)

Lights when a program list has been programmed.

7 RPT and RPT-1 (page 45)

RPT lights during repeat play. **RPT-1** lights during repeat one-track play.

8 RDM (page 46)

Lights during random play.

9 ATT (page 67)

Lights when the input attenuator is active for the currently selected analog input.

10 REC MODE (page 72)

Lights when Rec Mode is on.

11 Timer indicators (page 55)

Lights when the timer is set



Lights when the sleep timer is active

12  PRO LOGIC II (page 38)

Lights during Dolby Pro Logic II decoding.

13  DIGITAL (page 38)

Lights during playback of a Dolby Digital source.

14 Speaker indicators

These show which speakers are being used to output the current source (they are not placement diagrams). The illustrations below show some example displays.



5.1 channel surround sound



Stereo (2.1 channel) sound



3.1 channel sound with Dialogue enhancement on the center channel



5.1 channel surround sound with Virtual Surround Back mode active

(When headphones are connected, none of the speaker indicators are lit.)

15 PRGSVE (page 63)

Lights when progressive scan video output is selected.

16 ADV.SURR. (page 39)

Lights when one of the Advanced or Front Surround listening modes is selected.

17  (page 38)

Lights during playback of a DTS source.

18 kHz / MHz

Indicates the unit of the frequency shown in the character display (**kHz** for AM, **MHz** for FM)

19 Character display**20 ** (page 51)

Lights during multi-angle scenes on a DVD disc.

Remote control

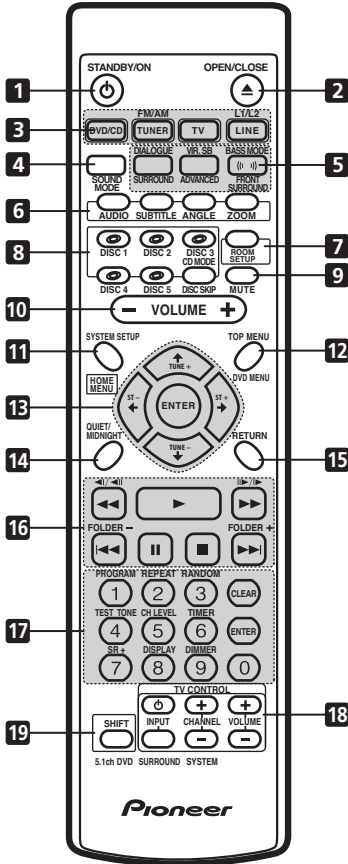

2 ▲ OPEN/CLOSE

Press to open/close the disc tray.

3 Function select buttons

Press to select the source you want to listen to (**DVD/CD, TUNER, TV, LINE**).

4 SOUND MODE

Use to adjust the tone and effect levels/settings. (pages 38–42)

5 Surround sound and enhancement buttons

SURROUND (page 38)

Use to select a Surround mode.

DIALOGUE (SHIFT + SURROUND)

(page 41)

Use to select a Dialogue mode.

ADVANCED (page 39)

Use to select an Advanced Surround mode.

VIR. SB (SHIFT + ADVANCED) (page 41)

Press to switch the Virtual Surround Back speaker effect on/off.

FRONT SURROUND (page 39)

Use to select a Front Surround listening mode.

BASS MODE (SHIFT + FRONT SURROUND) (page 42)

Use to select a Bass Mode.

6 DVD buttons

AUDIO (page 51)

Press to select an audio channel or language.

SUBTITLE (page 51)

Press to display/change the subtitle display.

ANGLE (page 51)

Press to change camera angle during DVD multi-angle scene playback.



Important

- Functions printed in green on the remote control are accessed using the **SHIFT** button. Press the function button you want while holding down **SHIFT**.

1 ⏻ STANDBY/ON (page 26)

Press to switch the system on or into standby.

ZOOM (page 51)

Press to change the screen zoom level.

7 ROOM SETUP (page 27)

Press to start Room Setup.

8 Disc selection buttons**DISC select buttons** (page 29)

Use to select discs in the player.

DISC SKIP / CD MODE

- During playback, press to start playing the next disc in the player.
- If the disc tray is open while no disc is playing, the tray rotates one disc space.
- If the disc tray was opened using the **EXCHANGE** button (front panel only), then pressing **DISC SKIP** rotates the disc tray two disc spaces. (page 30, 32)
- Use with **SHIFT** for **CD MODE**: Use to switch CD Mode on/off. (page 43)

9 MUTE

Press to mute all sound from the speakers and headphones (press again to cancel).

10 VOLUME

Use to adjust the volume.

11 HOME MENU / SYSTEM SETUP

- Press to display (or exit) the on-screen menu for Initial Settings, Play Mode functions, etc.
- Use with **SHIFT** for **SYSTEM SETUP**: Use to make various system and surround sound settings. (page 58)

12 DVD MENU / TOP MENU

- Press to display a DVD-Video disc menu, or the Disc Navigator if a VR mode DVD-RW, CD, Video CD, WMA/MP3 or JPEG disc is loaded.
- Use with **SHIFT** for **TOP MENU**: Use to display the top menu of a DVD disc in the play position (this may be the same as pressing **DVD MENU**).

13 Cursor buttons, ENTER and tuning buttons**Cursor buttons**

Use the cursor buttons (**↑/↓/←/→**) to navigate on-screen displays and menus.

ENTER

Press to select an option or execute a command.

TUNE +/-

Use to tune the radio.

ST +/-

Use to select station presets when listening to the radio.

14 QUIET/MIDNIGHT (page 41)

Use to select Quiet and Midnight listening modes.

15 RETURN

Press to return to a previous menu screen.

16 Playback controls

Press to start or resume playback.

◀◀ and ◀I/◀II

Use for reverse slow motion playback, frame reverse and reverse scanning.

▶▶ and II▶/I▶

Use for forward slow motion playback, frame advance and forward scanning.

◀◀◀ / FOLDER -

Press to jump to the beginning of the current chapter/track, then to previous chapters/tracks.

Press **SHIFT + ◀◀◀** to jump to the beginning of the previous folder

▶▶▶ / FOLDER +

Press to jump to the next chapter/track (or folder by pressing **SHIFT + ▶▶▶**).

II

Press to pause playback; press again to restart.



Press to stop playback.

17 Number buttons and SHIFT functions

Use the number buttons for selecting chapters/tracks from a disc directly; use with the **SHIFT** button to access the functions printed in green.

PROGRAM (SHIFT + 1) (page 47)

Use to program/play a program list.

REPEAT (SHIFT + 2) (page 45)

Use to select a repeat play mode.

RANDOM (SHIFT + 3) (page 46)

Use to select a random play mode.

TEST TONE (SHIFT + 4) (page 60)

Use to output the test tone (for speaker setup).

CH LEVEL (SHIFT + 5) (page 60)

Use to adjust the speaker level.

TIMER (SHIFT + 6) (page 55)

Press to display the clock and to access the timer menu.

SR+ (SHIFT + 7) (page 17)

Press to switch SR+ on or off.

DISPLAY (SHIFT + 8) (page 52)

Press to display/change disc information shown on-screen.

DIMMER (SHIFT + 9)

Press to switch between normal and dimmed front panel display.

CLEAR

Press to clear an entry.

ENTER

Press to select menu options, etc. (works exactly the same as the **ENTER** button in **13** above).

18 TV CONTROL buttons

These buttons are dedicated to control the TV assigned to the **TV** button.



Use to turn on/off the power of the TV.

INPUT

Use to select the TV function.

TV CHANNEL +/-

Use to select channels.

TV VOLUME +/-

Use to adjust the volume on your TV.

19 SHIFT

Use to access the functions/commands printed in green on the remote (press the button for the function you want while holding down **SHIFT**).

Chapter 4

Getting started

Switching on and setting up

After making sure everything is connected up properly, you're ready to switch on. The first thing to do is to tell the system what kind of TV you're using, standard or widescreen.

After that you can set up the surround sound for your room, and set the clock so that you can use the timer features.

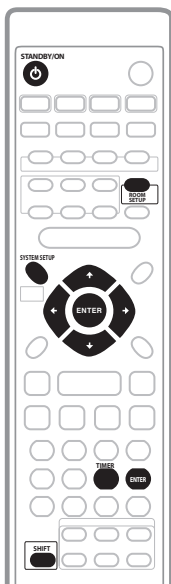

- 1 Press **STANDBY/ON** (on the remote or on the front panel) to switch the system on.

Also make sure that your TV is switched on and that the video input is set to this system. You should see the welcome screen displayed.

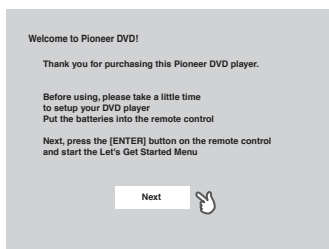

- 2 Press **ENTER** to move on to the next screen.

- 3 Use the **←/→** (cursor left/right) buttons to select either 'Wide screen' or 'Standard size screen' according to the kind of TV you have, then press **ENTER**.

See also *Screen sizes and disc formats* on page 77 if you're not sure which one to choose.

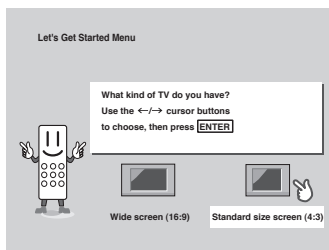

4 Press ENTER again to finish setting up.

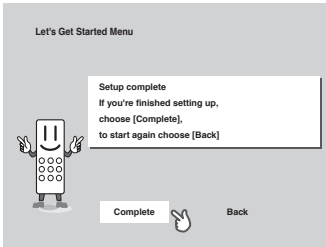

- Use the **→** (cursor right) button to select **BACK** then press **ENTER** if you want to go back and change the setting you just made.



Tip

- You can also use the **▲ OPEN/CLOSE** button on the front panel or the function buttons (**DVD/CD**, **TUNER**, etc.) to switch the system on from standby.



FAQ

- *The system switches on, but there is nothing displayed on my TV.*
Make sure that the TV is set to the correct video input (not a TV channel). For example, if you connected this system to the **VIDEO 1** input on your TV, switch your TV to **VIDEO 1**.

Setting the clock

Setting the clock allows you to use the timer features.

- 1 Press **TIMER (SHIFT + 6)**.
 - If you are adjusting the clock, rather than setting it for the first time, press **TIMER (SHIFT + 6)** again.

2 If '**Clock ADJ?**' isn't already shown in the display, press **←** or **→** (cursor left or right) until you see it.

3 Press **ENTER**.

4 Use the **↑/↓** (cursor up/down) buttons to set the hour.

5 Press **ENTER**.

6 Use the **↑/↓** (cursor up/down) buttons to set the minute.

7 Press **ENTER** to confirm.

The display flashes to indicate the clock is set.



Tip

- Press **TIMER (SHIFT + 6)** anytime to display the clock.



Note

- If you unplug the system from the wall outlet, or there is a power outage, you will need to set the clock again.

Using the Room Setup

After you have set up your speakers to your liking (see *Placing the speakers* on page 11), make sure you calibrate your system for surround sound. This is a quick and easy way to get good surround sound for your room. For more detailed surround sound setup, see *Surround sound and other settings* on page 58.

1 If the system isn't already on, press **⏻ STANDBY/ON** to switch it on.

2 Press **ROOM SETUP**.

- If you have previously set up the room type and seating position, the display will show the current room settings.

3 Press ENTER.

4 Use the ↑/↓ (cursor up/down) buttons to select a room type then press ENTER.

Choose one of the following depending on your room size:

- **S** – Smaller than average room
- **M** – Average room
- **L** – Larger than average room

5 Use the ↑/↓ (cursor up/down) buttons to select a seating position setting, then press ENTER.

Choose one of the following depending on where your main listening position is:

- **Fwd** – If you are nearer to the front speakers than the surround speakers
- **Mid** – If you are equal distance from the front and surround speakers
- **Back** – If you are nearer to the surround speakers than the front speakers



Note

- The Room Setup automatically sets up channel levels and channel delay. If you have already set the channel levels manually (see *Setting the channel levels* on page 60), you will see **Room Set?** in the display when you first press the **ROOM SETUP** button. If you continue, the previous settings will be overwritten.

Setting up the remote to control your TV

You can set up the supplied remote to control your TV using the **TV CONTROL** buttons.

1 Switch on your TV.

2 Find the name of the manufacturer of your TV in the Preset Code List on page 79.

Next to each manufacturer is one or more three digit codes. These tell the remote what kind of TV you have.

If the name of the manufacturer of your TV does not appear in the table, you won't be able to set up this remote to control your TV. Note that there are also cases where the preset codes listed for a manufacturer in the table may not work for your TV.

3 Point the remote at your TV, hold down the CLEAR button, then enter the three digit code for your TV.

The remote transmits an on/off signal to the TV. If you've entered the correct code, your TV should switch off.

If your TV doesn't turn off, repeat the procedure using the next code in the list until your TV switches off successfully. Once set, you can then use the individual TV controls shown below.

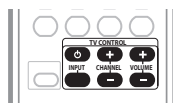

Button	What it does
	Switches your TV on or into standby.
CHANNEL +/-	Changes the TV channel.
VOLUME +/-	Adjusts the volume.
INPUT	Switches the TV's input between the built in TV tuner and an external video source.



Note

- The default setting is for a Pioneer TV.

Using the on-screen displays

For ease of use, this system makes extensive use of graphical on-screen displays (OSDs). You should get used to the way these work as you'll need to use them when setting up the system, using some of the playback features, such as program play, and when making more advanced settings for audio and video.

All the screens are navigated in basically the same way, using the cursor buttons to change the highlighted item and pressing **ENTER** to select it.

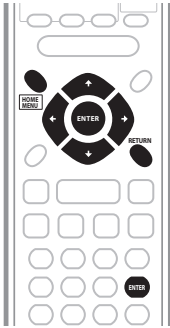

Button	What it does
HOME MENU	Displays/exits the on-screen display
← ↑ ↓ →	Changes the highlighted menu item
ENTER	Selects the highlighted menu item (both ENTER buttons work in exactly the same way)
RETURN	Returns to the main menu without saving changes



Important

- Throughout this manual, 'Select' means use the cursor buttons to highlight an item on-screen, then press **ENTER**.



Tip

- The button guide at the bottom of every OSD screen shows you which buttons you'll need to use for that screen.

Playing discs

The basic playback controls for playing DVD, CD, Video CD and WMA/MP3 discs are covered here. Further functions are detailed in chapter 6.

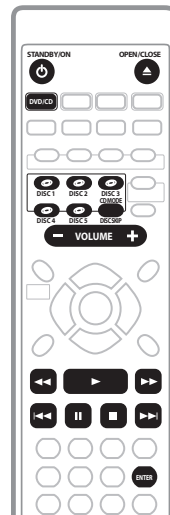

1 If the system isn't already on, press **⏻** **STANDBY/ON** to switch on.

If you're playing a DVD or Video CD, also turn on your TV and make sure that it is set to the correct video input.

2 Press ▲ OPEN/CLOSE to open the disc tray.

3 Load a disc.

Load a disc with the label side facing up in the front-most disc space, using the disc tray guide to align the disc. (If you're loading a double-sided DVD disc, load it with the side you want to play face down.)

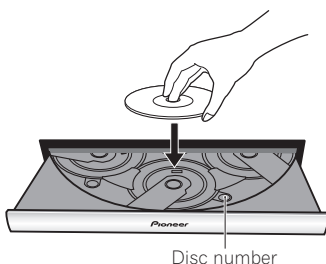

If you want to load more discs, press **DISC SKIP** (remote or front panel) to rotate the disc tray. You can load up to five discs at once.

- Do not place discs in the two partially accessible disc spaces, as it is easy to misalign them. Use only the front-most space.
- Do not load more than one disc in a space.
- Before loading or removing discs, always wait for the disc mechanism to come to a complete stop.
- Do not rotate the disc tray by hand. Always use the **DISC SKIP** button.
- Sometimes, when the disc tray mechanism is moving, the controls are inoperative.

4 Press ► (remote) or ►/II (front panel) to start playback of the disc loaded in the front-most disc space.

Alternatively, use the **DVD/CD** or **DISC** buttons on the remote, or the **DIRECT PLAY** buttons on the front panel to start playback of other discs.

If you're playing a DVD or Video CD, a menu may appear. See *DVD-Video disc menus* on page 33 and *Video CD PBC menus* on page 34 for how to navigate these.

If you're playing an MP3, WMA or JPEG disc, it may take a few seconds before playback starts, depending on the complexity of the file structure on the disc.

If you loaded a CD/CD-R/RW containing JPEGs, a slideshow will start. See *Viewing JPEG discs* on page 53 for more on playing these discs.









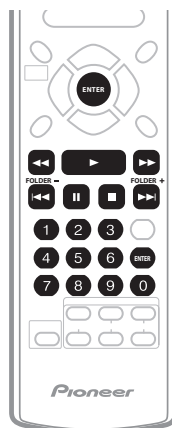

- See also *Options* on page 65 if the disc contains both WMA/MP3 audio files and JPEG picture files.

5 Use the VOLUME +/- button (or the front panel VOLUME knob) to adjust the volume.

Basic playback controls

The following table shows the basic controls on the remote for playing discs. You can find other playback features in *Playing discs* on page 43.



Button	What it does
	Starts playback. <i>DVD and Video CD:</i> If the display shows Resume or Last Mem playback starts from the resume or last memory point (see also <i>Resume and Last Memory</i> below.)
	Pauses a disc that's playing, or restarts a paused disc.
	Stops playback. <i>DVD and Video CD:</i> The display shows Resume . Press  again if you want to cancel the resume function. (See also <i>Resume and Last Memory</i> below.)
	Press to start fast reverse scanning. Press  (play) to resume normal playback.
	Press to start fast forward scanning. Press  (play) to resume normal playback.
	Skips to the start of the current track or chapter, then to previous tracks/chapters.
	Skips to the next track or chapter.
FOLDER +/-	Skips to the next/previous folder when playing MP3 or WMA discs.



Button	What it does
Numbers	Use to enter a title/track number. Press ENTER to select (or wait a few seconds). <ul style="list-style-type: none"> • If the disc is stopped, playback starts from the selected title (for DVD) or track number (for CD/Video CD/WMA/MP3). • If the disc is playing, playback jumps to the start of the selected chapter or track.







Note

- You may find with some DVD discs that some playback controls don't work in certain parts of the disc. This is not a malfunction.

Using the front panel controls

The  **OPEN/CLOSE** and  (stop) buttons on the front panel work the same way as the remote control equivalents.

The front panel scan and skip buttons (  and  ) are combined. Press once for chapter/track skip, or press and hold for scanning.

Resume and Last Memory

When you stop playback of a DVD or Video CD disc, **Resume** is shown in the display indicating that you can resume playback again from that point.

If the disc tray is not opened, the next time you start playback the display shows **Resume** and playback resumes from the resume point.

For DVD discs only: If you change discs using the **DISC SKIP**, **DISC** or **DIRECT PLAY** buttons, or take the disc out of the player, the play position is stored in memory. When you load the disc next time, the display shows **Last Mem** and you can resume playback (this works for up to five discs).

If you want to clear the resume/last memory point, press ■ (stop) while **Resume** or **Last Mem** is displayed.



Note

- When a Video CD is loaded, the Resume point is lost if the system is switched off, or switched to a function other than **DVD/CD**.
- For the Last Memory function to work, you must press ■ (stop) to stop playback before opening the disc tray or changing the disc.
- The Last Memory function doesn't work with VR format DVD-RW discs.

Changing discs

You can change any of the discs not in the play position using the **EXCHANGE** button on the front panel. Because the disc in the play position is unaffected, you can use this button to change discs even during playback.

1 Press **EXCHANGE** to open the disc tray.

- The **EXCHANGE** button only works when there is at least one disc loaded.

2 Load a disc with the label side facing up, using the disc tray guide to align the disc.

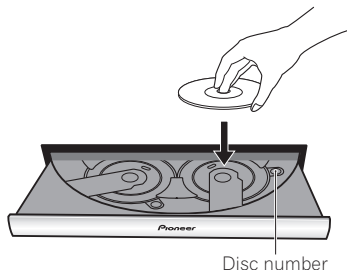

- If you want to load more discs, press **DISC SKIP** to rotate the disc tray two disc spaces.
- Before loading or removing discs, always wait for the disc mechanism to come to a complete stop.
- Load discs only in the two fully accessible disc spaces. Do not try and load discs into any of the other spaces; they may not load correctly and cause the system to malfunction.
- Do not rotate the disc tray by hand. Always use the **DISC SKIP** button.
- Do not obstruct the movement of the disc tray.

3 Press **EXCHANGE** or ▲ **OPEN/CLOSE** to close the disc tray.

- Always use the ▲ **OPEN/CLOSE** or **EXCHANGE** button to close the disc tray after exchanging discs. Never push the disc tray shut by force.



FAQ

- After I load a DVD disc, it ejects automatically after a few seconds!

Most likely, the disc is the wrong region for your system. The region number should be printed on the disc; check it against the region number of the system (which you can find on the rear panel). See also *DVD Video regions* on page 68.

If the region number is OK, it may be that the disc is damaged or dirty. Clean the disc and look for signs of damage. See also *Using and taking care of discs* on page 68.

- *Why won't the disc I loaded play?*

First check that you loaded the disc the right way up (label side up), and that it's clean and not damaged. See *Using and taking care of discs* on page 68 for information on cleaning discs.

If a disc loaded correctly won't play, it's probably an incompatible format or disc type, such as DVD Audio or DVD-ROM. See *Disc / content format playback compatibility* on page 8 for more on disc compatibility.

- *I have a widescreen TV so why are there black bars at the top and bottom of the screen when I play some discs?*

Some movie formats are such that even when played on a widescreen TV, black bars are necessary at the top and bottom of the screen. This is not a malfunction.

- *I have a standard (4:3) TV and set the system to show widescreen DVDs in pan & scan format, so why do I still get black bars top and bottom with some discs?*

Some discs override the display preferences of the system, so even if you have **4:3 (Pan & Scan)** selected, those discs will still be shown in letterbox format. This is not a malfunction.

DVD-Video disc menus

Many DVD-Video discs contain menus from which you can select what you want to watch. They may give access to additional features, such as subtitle and audio language selection, or special features such as slideshows. See the disc packaging for details.

Sometimes DVD-Video menus are displayed automatically when you start playback; others only appear when you press **DVD MENU** or **TOP MENU**.

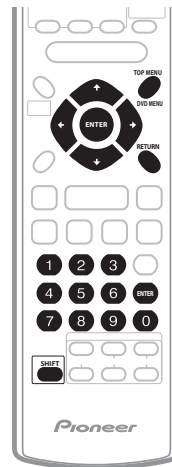

Button	What it does
TOP MENU (SHIFT + DVD MENU)	Displays the 'top menu' of a DVD disc—this varies with the disc.
DVD MENU	Displays a DVD disc menu—this varies with the disc and may be the same as the 'top menu'.
← ↑ ↓ →	Moves the cursor around the screen.

Button	What it does
ENTER	Selects the current menu option.
RETURN	Returns to the previously displayed menu screen.
Numbers	Highlights a numbered menu option (some discs only). Press ENTER to select.

Video CD PBC menus

Some Video CDs have menus from which you can choose what you want to watch. These are called PBC (Playback control) menus.

You can play a PBC Video CD without having to navigate the PBC menu by pressing **■** (stop) then starting playback using a number button to select a track, rather than **▶** (play) (or **▶/||** on the front panel).

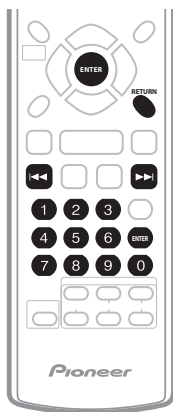



Button	What it does
RETURN	Displays the PBC menu.
Numbers	Selects a numbered menu option.

Button	What it does
◀◀	Displays the previous menu page (if there is one).
▶▶	Displays the next menu page (if there is one).
ENTER	Press to select highlighted menu option.

Listening to the radio

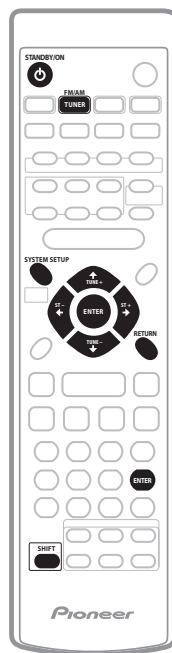
The tuner can receive both FM and AM broadcasts, and lets you memorize your favorite stations so you don't have to manually tune in every time you want to listen.



1 If the system isn't already on, press  **STANDBY/ON** to switch on.

2 Press **TUNER** to switch to the tuner, then press repeatedly to select the **AM** or **FM** band.

The display indicates the tuner band and the frequency.

- If you're using the front panel controls, the **TUNER** button switches between FM, AM and station presets (see *Memorizing stations* on page 35).

3 Tune to a frequency.

There are three tuning modes—manual, auto, and high-speed:

- **Manual tuning:** Press **TUNE +/-** repeatedly to change the displayed frequency.
- **Auto tuning:** Press and hold **TUNE +/-** until the frequency display starts to move, then release. The tuner will stop on the next station it finds. Repeat to search for other stations.
- **High-speed tuning:** Press and hold **TUNE +/-** until the frequency display starts to move rapidly. Keep the button held down until you reach the frequency you want. If necessary, fine tune the frequency using the manual tuning method.



Tip

- You can use the **I◀◀◀** and **▶▶▶I** buttons on the front panel instead of the **TUNE +/-** buttons.

Improving poor FM reception

If you're listening to an FM station in stereo but the reception is weak, you can improve the sound quality by switching to mono.

1 Press **SYSTEM SETUP (SHIFT + HOME MENU)**.

2 Use the **←/→** (cursor left/right) buttons to choose 'FM Mode?', then press **ENTER**.

3 Use the **↑/↓** (cursor up/down) buttons to select 'FM Mono' or 'FM Auto', then press **ENTER**.

Select **Auto** in step **3** to switch back to auto-stereo mode (the stereo indicator lights when receiving a stereo broadcast).

Memorizing stations

You can save up to 30 station presets so that you always have easy access to your favorite stations without having to tune in manually each time.

1 Tune to an **AM** or **FM** radio station.

For the FM band, select mono or auto-stereo reception as necessary. This setting is saved along with the preset.

2 Press **SYSTEM SETUP (SHIFT + HOME MENU)**.

3 Use the **←/→** (cursor left/right) buttons to choose 'St. Memory?' then press **ENTER**.

4 Use the **↑/↓** (cursor up/down) buttons to select the station preset you want.

There are 30 preset locations; each can store one station preset.

5 Press **ENTER** to save the station preset.



Note

- If the system is unplugged from the power supply completely, saved stations will remain for several days, after which you'll have to save them again.

Listening to station presets

- 1 **Make sure the TUNER function is selected.**
- 2 **Use ST +/- or the number buttons to select a station preset.**
 - If you are using the front panel controls, press **TUNER FM/AM/ST.** until you're in station preset mode, then use the **◀◀◀◀** and **▶▶▶▶** buttons to select a station preset.

Listening to other sources

You can connect up to three external sources (TV, satellite receiver, etc.) to this system, including one digital source. See also *Listening to TV audio through this system* on page 16 and *Connecting auxiliary components* on page 71.

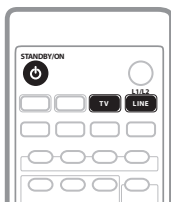

- 1 **If the system isn't already on, press  STANDBY/ON to switch on.** Also make sure that the external source (TV, satellite receiver, etc.) is switched on.
- 2 **Select the source you want to listen to.**
 - If you're using the remote control, press **TV** to select the **TV** input, or use the **LINE (L1/L2)** button to select the **LINE 1** or **LINE 2** input.
 - The **TV/L1/L2** button on the front panel switches between the three inputs.
- 3 **If necessary, start playback of the external source.**

Chapter 5

Listening to your system

About the listening modes

As explained in *Placing the speakers* on page 11, there are two basic surround speaker setup options available. Of course you can select any of the listening modes regardless of how you place your speakers, but you will achieve the best surround effect by using the listening modes in conjunction with your speaker setup:

- **Standard surround 5-spot setup** – Use the Standard (*Listening in surround sound* on page 38) and Advanced (*Using the Advanced Surround effects* on page 39) surround listening modes with this setup.
- **Front surround 3-spot setup** – See *Using Front Surround* on page 39 for the options available with this speaker setup.

Make sure you have completed *Using the Room Setup* on page 27. For a more detailed surround sound setup, see *Using the System Setup menu* on page 58.



Note

- Certain features explained in this section may not be possible depending on the source (for example, 88.2/96 kHz sources), or a conflicting system setting. See *Error Messages* on page 76 for more on this.

Auto listening mode

The Auto listening mode is the simplest way to listen to any source as it was mastered: the output from the speakers mirrors the channels from the source material.

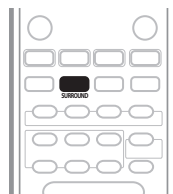

- **Press SURROUND to select the 'Auto' listening mode.**

If the source is Dolby Digital or DTS, the **DIGITAL** or **DTS** indicator on the front panel lights.



Note

- Any previously active Dolby Pro Logic or Advanced Surround mode is canceled when Auto listening mode is selected.

Listening in surround sound

You can listen to any source—stereo or multichannel, analog or digital—in surround sound. Surround sound is generated from stereo sources using one of the Dolby Pro Logic decoding modes.

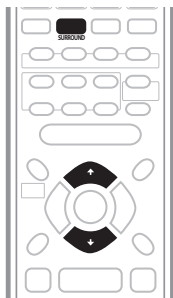

- Press **SURROUND** repeatedly to select a listening mode (or press **SURROUND** then use the **↑/↓** (cursor up/down) buttons).

The listening mode choices that appear in the display will vary according to the type of source that's playing.

- **Auto** – See *Auto listening mode* above.
- **Dolby Digital / DTS** – Dolby Digital or DTS decoding (depending on the source).
- **Pro Logic** – 4.1 channel surround sound for use with any two-channel source
- **PL II Movie** – Pro Logic II 5.1 channel surround sound, especially suited to movie sources, for use with any two-channel source
- **PL II Music** – Pro Logic II 5.1 channel surround sound, especially suited to music sources, for use with any two-channel source (see also *Dolby Pro Logic II Music settings* below)
- **Stereo** – See *Listening in stereo* below



Note

- When listening in **Dolby Digital / DTS** mode, two-channel material will automatically be played in surround sound using Dolby Pro Logic II decoding.
- Dolby Digital / DTS sources that use only the center channel cannot be played back in surround sound.

Dolby Pro Logic II Music settings

When listening in Dolby Pro Logic II Music mode, there are three further parameters you can adjust: Center Width, Dimension, and Panorama.

1 With Dolby Pro Logic II Music mode active, press SOUND MODE.

2 Use the **←/→ (cursor left/right) buttons to select 'C Width', 'Dimen.' or 'Pnrm.'**

- **C Width** (Center Width): Makes the center channel wider (higher settings) or narrower (lower settings)
- **Dimen.** (Dimension): Makes the sound more distant (minus settings), or more forward (positive settings)
- **Pnrm.** (Panorama): Creates more spacious surround sound

3 Use the **↑/↓ (cursor up/down) buttons to adjust the setting.**

Center Width is adjustable between **0** and **7**; Dimension between **-3** and **+3**. Panorama is **On** or **Off**.

4 Press ENTER to confirm.

Using the Advanced Surround effects

Advanced Surround effects can be used with multichannel or stereo sources for a variety of additional surround sound effects. The 5-spot setup described in *Placing the speakers* on page 11 should be used with these effects.

For more options, see *Adjusting the Advanced and Front Surround effect level* below.

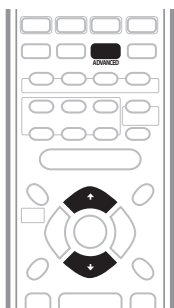

- **Press ADVANCED to select an Advanced Surround mode (or press ADVANCED then use the ↑/↓ (cursor up/down) buttons).**

Press repeatedly to select from:

- **Adv. Movie** – Gives a movie theater-type sound
- **Adv. Music** – Gives a concert hall-type sound
- **Expanded** – Creates an extra wide surround field
- **TV Surr.** – Designed for mono or stereo TV broadcasts and other sources
- **Sports** – Designed for sports and other programs based on commentary
- **Game** – Creates surround sound from video game sources
- **5ch Stereo** – Designed to give powerful surround sound to stereo music sources

Using Front Surround

The Front Surround modes are effective when you are using the Front surround 3-spot speaker setup as described in *Placing the speakers* on page 11. The surround speakers should be placed on top of the front speakers and oriented either towards the walls, or straight ahead, depending on which mode you are using (see below).

For more options, see *Adjusting the Advanced and Front Surround effect level* below.

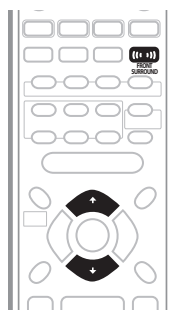

- **Press FRONT SURROUND to select an Front Surround mode (or press FRONT SURROUND then use the ↑/↓ buttons).**

Press repeatedly to select from:

- **Frnt. Movie** – The Front Surround Movie mode emphasizes directionality, giving you a realistic movie theater-type sound.
- **Frnt. Music** – The Front Surround Music mode provides greater breadth and depth to music sources, enveloping you with a concert hall-type sound.
- **ExtraPower** – The Extra Power mode gives additional energy and depth to a stereo source by using the surround speakers in addition to the front speakers.

If you have selected **Frnt. Movie** or **Frnt. Music**, you will achieve best results by turning each surround speaker about 60° towards the closest wall. With **ExtraPower**, orient the surround speakers in the same direction as the front speakers (towards the listening position).

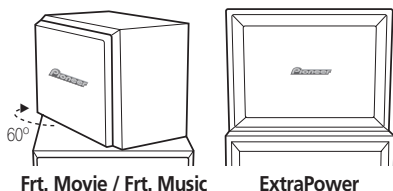

Adjusting the Advanced and Front Surround effect level

You can emphasize or reduce the effect of the Advanced and Front Surround modes as you like. You can set the effect level for all modes independently.

- 1 **With one of the Advanced or Front Surround modes active, press SOUND MODE.**
- 2 **Use the ←/→ (cursor left/right) buttons to select 'Effect'.**
- 3 **Use the ↑/↓ (cursor up/down) buttons to adjust the effect level.**
The effect level can be adjusted from **10** (min) to **90** (max).
- 4 **Press ENTER to confirm.**

Listening in stereo

You can listen to any source—stereo or multichannel, analog or digital—in stereo. When playing a multichannel source, stereo sound is created by downmixing all channels to the front left/right speakers and the subwoofer.

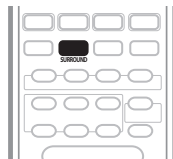

- **Press SURROUND repeatedly until 'Stereo' shows in the display.**

Any active Advanced Surround or Front Surround mode is canceled.

Listening with headphones

When headphones are connected, only the **Stereo** (default) and **Phones Surround** (virtual surround sound for headphones) modes are available.

When you disconnect them it reverts to the previous mode.

- **With headphones connected, press ADVANCED or FRONT SURROUND to select 'Phones Surround' or SURROUND to select 'Stereo'.**

Enhancing dialogue

- Default setting: **Dialog Off**

The Dialogue Enhancement feature is designed to make the dialog stand out from other background sounds in a TV or movie soundtrack.

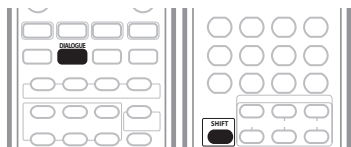

- Press **DIALOGUE (SHIFT + SURROUND)** to select the amount dialog enhancement.

Press repeatedly to select from:

- **Dialog Off** – No dialog enhancement
- **Dialog Mid** – Moderate dialog enhancement
- **Dialog Max** – Strong dialog enhancement

Listening with a virtual surround back speaker

- Default setting: **Vir. SB Off**

The Virtual Surround Back feature can be used when listening in surround sound (using the 5-spot setup described in *Placing the speakers* on page 11) to simulate an added surround back channel. In a real theater the surround back speaker would be directly behind you, creating more cohesive and realistic surround sound.

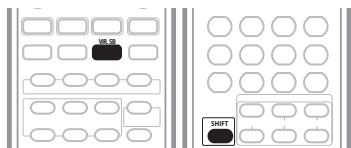

- Press **VIR. SB (SHIFT + ADVANCED)** repeatedly to switch between 'Vir. SB On' and 'Vir. SB Off'.



Note

- You can't use Virtual Surround Back when using the **Stereo** listening mode (or **Auto** with stereo sources).
- If you are using the The Front surround 3-spot setup (see *Placing the speakers* on page 11), switch the Virtual Surround Back feature off.
- If there is no surround channel, Virtual Surround Back has no effect.

Using Quiet and Midnight listening modes

- Default setting: **Off**

The Quiet listening feature reduces excessive bass or treble in a sound source. You can use this feature if the music is a little bit harsh and you would like a smoother sound.

The Midnight listening feature allows you to hear effective surround sound of movies at low volume levels. The effect automatically adjusts according to the volume at which you're listening.

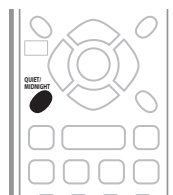

- Press **QUIET/MIDNIGHT** repeatedly to switch between 'Quiet', 'Midnight' and 'Off'.

Adjusting the bass and treble

Use the bass and treble controls to adjust the overall tone.

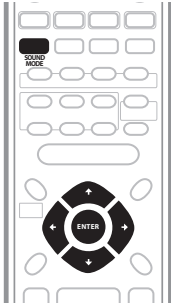

- 1 Press **SOUND MODE**.
- 2 Use the **←/→** (cursor left/right) buttons to select 'Bass' or 'Treble'.
- 3 Use the **↑/↓** (cursor up/down) buttons to adjust the sound.
The bass and treble can be adjusted from **-3** to **+3**.
- 4 Press **ENTER** to confirm.

Note

- Bass and treble adjustment is not possible when the **Quiet** or **Midnight** modes are active.

Boosting the bass level

There are three bass modes you can use to enhance the bass in a source.

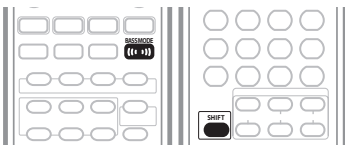

- Press **BASS MODE (SHIFT + FRONT SURROUND)** repeatedly to choose an option that fits the source you're listening to.
 - **Music** – Can be used with music to give a deeper bass sound
 - **Cinema** – Good for action movies or movies with lots of sound effects
 - **P. Bass** – Can be used with music sources to bring the beat of the music (or soundtrack) to the forefront
 - **Off** – Switch off the bass boost if it causes excessive bass (i.e. it sounds 'boomy') in the source

Chapter 6

Playing discs



Note

- Some DVD discs restrict the use of some functions (random or repeat, for example). This is not a malfunction.
- When playing Video CDs, some of the functions are not available during PBC playback. If you want to use them, start the disc playing using a number button to select a track.
- Many features are not available when using unfinalized CD-R/RW discs.

Playing only CDs and WMA/MP3 discs (CD mode)

Using this feature you can play only the CDs and WMA/MP3 discs loaded in the disc tray—automatically skipping over any DVDs and Video CDs loaded. This may be useful if you have a mixture of discs loaded but only want to play music: you don't have to keep track of what kind of disc is where in the disc tray.

1 Press CD MODE (SHIFT + DISC SKIP) to switch CD mode on.

- The indicator on the front panel lights when CD mode is on.

2 Press ► (play) to start playback.

The first CD loaded automatically starts to play.

Once all the CD/WMA/MP3 discs loaded have played, playback automatically stops.

- To cancel the CD mode, press **CD MODE (SHIFT + DISC SKIP)** again.
- If you open the disc tray and load a DVD, Video CD or JPEG disc in the front-most position then press ► (play) (on the front panel), CD mode is canceled.



Note

- You can't switch on CD mode while playing a DVD or Video CD. Stop playback first.
- Although program play is not possible in CD mode, it is possible to program a playlist. When you start program play-back, however, CD mode is canceled.
- Repeat and random play is possible in CD mode (see *Using repeat play* on page 45 and *Using random play* on page 46).

Scanning discs

You can fast-scan discs forward or backward at various different speeds.

1 During playback, press ◀◀ or ▶▶ to start scanning.

- There is no sound while scanning DVDs and Video CDs, and no subtitles while scanning DVDs.

2 Press repeatedly to increase the scanning speed.

- The scanning speed is shown on-screen.

3 To resume playback, press ► (play).

- When scanning a Video CD or a WMA/MP3 track, playback automatically resumes at the end or beginning of the track.
- Depending on the disc, normal playback may automatically resume when a new chapter is reached on a DVD disc.

Playing in slow motion

You can play DVDs and Video CDs at four different forward slow motion speeds. DVD discs can also be played at two reverse speeds.

- 1 **During playback, press II (pause).**
- 2 **Press and hold ◀|/◀|| or |||/▶ until slow motion playback starts.**
 - The slow motion speed is shown on-screen.
 - There is no sound during slow motion playback.
- 3 **Press repeatedly to change the slow motion speed.**
- 4 **To resume normal playback, press ▶ (play).**
 - Depending on the disc, normal playback may automatically resume when a new chapter is reached.

Frame advance/frame reverse

You can advance or back up DVD discs frame-by-frame. With Video CDs you can only use frame advance.

- 1 **During playback, press II (pause).**
- 2 **Press ◀|/◀|| or |||/▶ to reverse or advance a frame at a time.**
- 3 **To resume normal playback, press ▶ (play).**
 - Depending on the disc, normal playback may automatically resume when a new chapter is reached.

Using the Disc Navigator to browse the contents of a disc

Use the Disc Navigator to browse through the contents of a disc to find the part you want to play. You can use the Disc Navigator when a disc is playing or stopped (a disc must be loaded).

- 1 **Press HOME MENU and select 'Disc Navigator' from the on-screen display.**



- With most discs, you can also press **DVD MENU** to go directly to the Disc Navigator.

2 Select what you want to play.

Depending on the type of disc you have loaded, the Disc Navigator looks slightly different.

The screen for DVD discs shows the titles on the left and the chapters on the right. Select a title, or a chapter within a title.

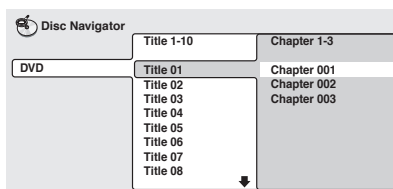

For a VR format DVD-RW disc select between the **PlayList** and **Original** areas of the disc, or a title. Press → (cursor right) to preview the title.

- You can't switch between **Original** and **PlayList** during playback.
- Not all VR format DVD-RW discs have a Playlist.

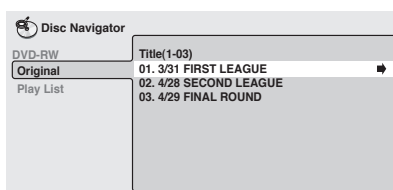

The screen for CDs and Video CDs shows a list of tracks.

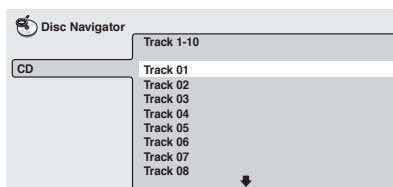

The screen for WMA/MP3 discs shows the folder names on the left and the track names on the right (note that any folder and track names that contain accented or non-roman characters, will show up with generic names – **F_033**, **T_035**, etc.).

Select a folder, or a track within a folder.

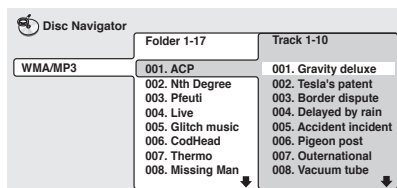

Playback starts after you press **ENTER**.



Tip

- Another way to find a particular place on a disc is to use one of the search modes. See *Searching a disc* on page 50.

Looping a section of a disc

The A-B Repeat function allows you to specify two points (A and B) within a track (CD and Video CD) or title (DVD) that form a loop which is played over and over.

- You can't use A-B Repeat with WMA/MP3 discs.

1 During playback, press HOME MENU and select 'Play Mode'.

2 Select 'A-B Repeat' from the list of functions on the left.

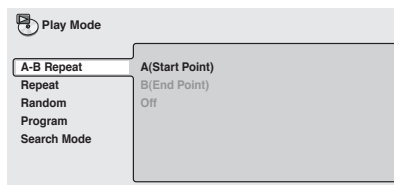

3 Press ENTER on 'A(Start Point)' to set the loop start point.

4 Press ENTER on 'B(End Point)' to set the loop end point.

After pressing **ENTER**, playback jumps back to the start point and plays the loop.

- The minimum loop time is 2 seconds.

5 To resume normal playback, select 'Off' from the menu.

Using repeat play

There are various repeat play options, depending on the kind of disc loaded. It's also possible to use repeat play together with program play to repeat the tracks/chapters in the program list (see *Creating and editing a DVD program list* on page 47 and *Creating and editing a non-DVD program list* on page 48).

- 1 During playback, press **HOME MENU** and select 'Play Mode'.
- 2 Select 'Repeat' from the list of functions on the left.

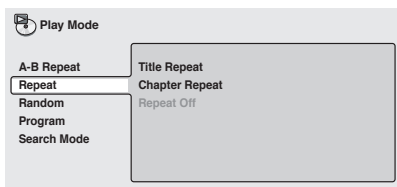

- 3 Select a repeat play option. If program play is active, select **Program Repeat** to repeat the program list, or **Repeat Off** to cancel.

- For DVD discs, select **Title Repeat** or **Chapter Repeat** (or **Repeat Off**).

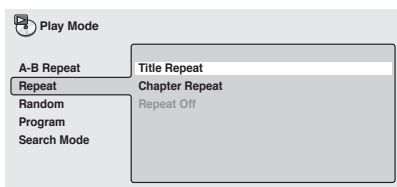

- For CDs and Video CDs, select **All Discs Repeat**, **Disc Repeat** or **Track Repeat** (or **Repeat Off**).
- For WMA/MP3 discs, select **All Discs Repeat**, **Disc Repeat**, **Folder Repeat** or **Track Repeat** (or **Repeat Off**).

 **Tip**

- You can also use the **REPEAT (SHIFT + 2)** button on the remote to select a repeat play mode. The repeat mode is indicated in the front panel display and on-screen. The repeat modes available are the same as when choosing from the **Play Mode** menu.

- If you've created a program list, **Program Repeat** is also available.
- During random playback (see below), **Random Repeat** is also available.

Using random play

With a DVD you can choose to play titles or chapters within a title in a random order. With CDs, Video CDs, MP3 or WMA discs, you can play all the discs at random, or just the contents of a single disc.

You can set the random play option when a disc is playing or stopped. However, you can't use random play together with program play.

- You can't use random play with VR format DVD-RW discs, or while a DVD disc menu is being displayed.

- 1 Press **HOME MENU** and select 'Play Mode'.

- 2 Select 'Random' from the list of functions on the left.

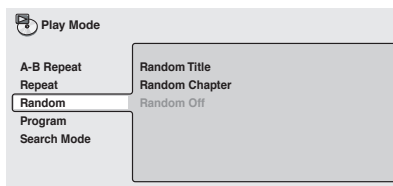

- 3 Select a random play option.
 - For DVD-Video discs, select **Random Title** or **Random Chapter** (or **Random Off**)

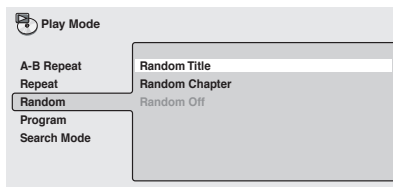

- For CDs, Video CDs and WMA/MP3 discs, select **Random All**, **Random Disc** (or **Random Off**).
- The **Random All** function ignores DVDs loaded in the player.



Tip

- Use the following controls during random play:

Button	What it does
■	Stop and cancel random play.
▶▶	Selects another track/chapter at random from those remaining.
◀◀	Returns to the beginning of the current track/chapter. You can't go back further than this.

- You can also use the **RANDOM (SHIFT + 3)** button on the remote to select a random play mode. The random mode is indicated in the front panel display and on-screen. The random modes available are the same as when choosing from the **Play Mode** menu. Press **ENTER** to start random play.
- To cancel random playback without stopping playback, press **CLEAR**. The disc will play to the end, then stop.

Creating and editing a DVD program list

This feature lets you program the play order of titles and chapters on the DVD disc currently in the play position.

If you want to program the play order of CDs, Video CDs or WMA/MP3 discs, see *Creating and editing a non-DVD program list* on page 48.

- You can't use Program play with VR format DVD-RW discs, or while a DVD disc menu is being displayed.

1 Make sure that the DVD disc you want to make the program list for is in the play position.

Use the **DISC** select buttons on the remote, or the **DIRECT PLAY** buttons on the front panel to select the disc.

2 Press HOME MENU and select 'Play Mode'.

- Alternatively, press **PROGRAM (SHIFT + 1)** and skip to step 5.

3 Select 'Program' from the list of functions on the left.

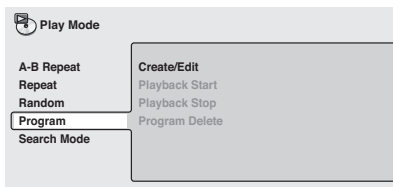

4 Select 'Create/Edit' from the list of program options.

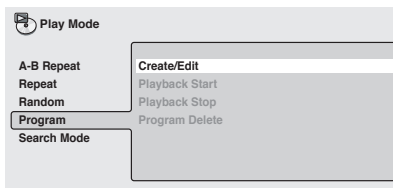

5 Select a title or chapter for the first/next step in the program list.

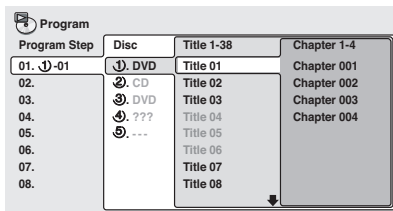

- When this screen first appears, the first title on the disc is highlighted. From here you can select a title, or a chapter within a title.
- Some titles and/or chapters of DVD discs may be grayed out, depending on the disc. Grayed out titles/chapters can't be added to the program list.

6 Press ENTER to add the highlighted item to the program list.

The program step number automatically moves to the next position.

Program Step	Disc	Title 1-38	Chapter 1-4
01. 01	1 DVD	Title 01	Chapter 001
02.	2 CD	Title 02	Chapter 002
03.	3 DVD	Title 03	Chapter 003
04.	4 ???	Title 04	Chapter 004
05.	5 ---	Title 05	
06.		Title 06	
07.		Title 07	
08.		Title 08	

7 Add further items to the program list in the same way.

- A program list can contain up to 24 steps.
- To clear a step in the program list, move to the **Program Step** column, highlight the step to clear and press **CLEAR**.
- To insert a step in the program list, move to the **Program Step** column and highlight the step where you want a new step to appear. After you select a title/chapter, all the program steps will move down one to make space for the new one.

8 To play the program list, press ► (play).

- Program play remains active until you turn off program play (see below), erase the program list (see below), or switch off the system.

Creating and editing a non-DVD program list

This feature lets you program the play order of folders and tracks on the CDs, Video CDs and WMA/MP3 discs loaded.

If you want to program the play order of a DVD disc, see *Creating and editing a DVD program list* on page 47.

1 Make sure that a non-DVD disc is in the play position.

Use the **DIRECT PLAY** buttons on the front panel to select a disc.

2 Press HOME MENU and select 'Play Mode'.

- Alternatively, press **PROGRAM (SHIFT + 1)** and skip to step 5.

3 Select 'Program' from the list of functions on the left.

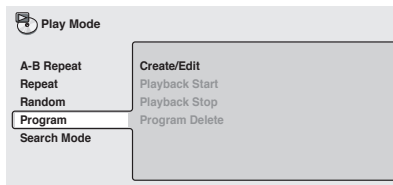

4 Select 'Create/Edit' from the list of program options.

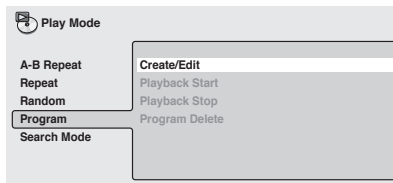

5 Select a folder or track for the first/next step in the program list.

Program Step	Disc	Folder 1-6	Track 1-10
01. -01	WMA/MP3	001. Electro A-M	001. Gravity Deluxe
02.	CD	002. Electro N-Z	002. Tesla's Patent
03.	DVD	003. Rock 1	003. Border Dispute
04.	???	004. Rock 2	004. Delayed by Rai
05.	---	005. Jazz	005. Pigeon Post
06.		006. Classical	006. Outernational
07.		007. Panic Button	007. Panic Button
08.		008. Accident Incide	008. Accident Incide

- When this screen first appears, the first folder or track of the disc in the play position is highlighted. From here you can select something on this disc, or move left to the **Disc** column and select something from one of the other discs loaded.
- With WMA/MP3 discs, you can select a folder, or an individual track in a folder.
- With CDs and Video CDs, select a track.
- Any DVDs loaded are shown grayed out and can't be selected.
- If the system has not yet determined the type of disc in a tray position, '???' is displayed as the disc type. If you select it, '???' is displayed in the middle and right columns. You can add items to the program list from this disc, although what you select must actually exist on the disc for it to play. Also, if the disc is a DVD, program play will be canceled when it comes to that disc in the program list
- If a tray position is empty, '---' is displayed.

6 Press ENTER to add the highlighted item to the program list.

The program step number automatically moves to the next position.

Program Step	Disc	Folder 1-6	Track 1-10
01. -001-003	WMA/MP3	001. Electro A-M	001. Gravity Deluxe
02. -001-003	CD	002. Electro N-Z	002. Tesla's Patent
03.	DVD	003. Rock 1	003. Border Dispute
04.	???	004. Rock 2	004. Delayed by Rai
05.	---	005. Jazz	005. Pigeon Post
06.		006. Classical	006. Outernational
07.		007. Panic Button	007. Panic Button
08.		008. Accident Incide	008. Accident Incide

7 Add further items to the program list in the same way.

- A program list can contain up to 24 steps.
- To clear a step in the program list, move to the **Program Step** column, highlight the step to clear and press **CLEAR**.
- To insert a step in the program list, move to the **Program Step** column and highlight the step where you want a new step to appear. After you select a folder/track, all the program steps will move down one to make space for the new one.

8 To play the program list, press ► (play).

- Program play remains active until you turn off program play (see below), erase the program list (see below), or switch off the system.



Tip

- Use the following controls during program play:

Button	What it does
HOME MENU	Save the program list and exit the program edit screen without starting playback.
	Skip to the next step in the program list.

Button	What it does
CLEAR	Switch off program play. Press while stopped to erase the program list.
RETURN	Exit the program edit screen without saving any changes.



Note

- The current playlist is erased if you change the type of disc in the play position (DVD or non-DVD) or select **Program Delete** from the **Play Mode** menu.
- DVD playback follows commands recorded on the disc. There may be cases where program play is automatically canceled or may not work. This is not a malfunction
- With Video CDs that feature PBC playback, make sure that the disc is stopped before you start making the program list.

Other functions available from the program menu

There are a number of other options in the program menu in addition to Create/Edit.

- **Playback Start** – Starts playback of a saved program list
- **Playback Stop** – Turns off program play, but does not erase the program list
- **Program Delete** – Erases the program list and turns off program play

Searching a disc

You can search DVD discs by title or chapter number, or by time. CDs can be searched by track number, and Video CDs by track number or time. WMA/MP3 discs can be searched by folder or track number.

1 Press HOME MENU and select 'Play Mode'.

2 Select 'Search Mode' from the list of functions on the left.

The search options that appear depend on the kind of disc loaded. The screen below shows the DVD search options.

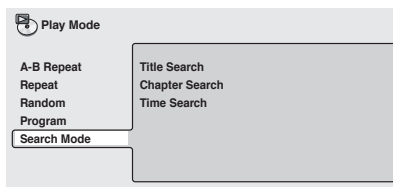

3 Select a search mode.

- The disc must be playing in order to use time search.

4 Use the number buttons to enter a title, chapter, folder or track number, or a time.

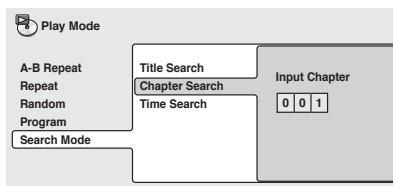

- For a time search, enter the number of minutes and seconds into the currently playing title (DVD) or track (Video CD) you want playback to resume from. For example, press **4, 5, 0, 0** to have playback start from 45 minutes into the disc. For 1 hour, 20 minutes and 30 seconds, press **8, 0, 3, 0**.

5 Press ENTER to start playback.

Switching subtitles

Some DVD discs have subtitles in one or more languages; the disc box will usually tell you which subtitle languages are available. You can switch subtitle language during playback.

- Press **SUBTITLE** repeatedly to select a subtitle option.

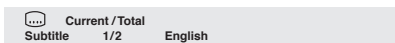

Note

- Some discs only allow you to change subtitle language from the disc menu. Press **DVD MENU** to access.
- To set subtitle preferences, see *Language settings* on page 64.

Switching DVD audio language

When playing a DVD disc recorded with dialog in two or more languages, you can switch audio language during playback.

- Press **AUDIO** repeatedly to select an audio language option.



Note

- Some discs only allow you to change audio language from the disc menu. Press **DVD MENU** to access.
- To set audio language preferences, see *Language settings* on page 64.

Switching audio channels when playing a Video CD

When playing a Video CD, you can switch between stereo, just the left channel or just the right channel.

- Press **AUDIO** repeatedly to select an audio channel option.



Zooming the screen

Using the zoom feature you can magnify a part of the screen by a factor of 2 or 4, while watching a DVD or Video CD.

- 1 During playback, use the **ZOOM** button to select the zoom factor (Normal, 2x or 4x).

- Since DVD and Video CD has a fixed resolution, picture quality will deteriorate, especially at 4x zoom. This is not a malfunction.

- 2 Use the cursor buttons to change the zoomed area.

You can change the zoom factor and the zoomed area freely during playback.

- If the navigation square at the top of the screen disappears, press **ZOOM** again to display it.



Note

- If you are displaying subtitles, these will disappear when the screen is zoomed. They will reappear when you return the screen to normal.

Switching camera angles

Some DVD discs feature scenes shot from two or more angles—check the disc box for details.

When a multi-angle scene is playing, a  icon appears on screen and in the front panel display to let you know that other angles are available (this can be switched off if you prefer—see *Display settings* on page 64).

- **During playback (or when paused), press ANGLE to switch angle.**

Displaying disc information

OSD disc information

Various track, chapter and title information can be displayed on-screen while a disc is playing.

- **To show/switch/hide the information displayed, press DISPLAY (SHIFT + 8) repeatedly.**

- When a disc is playing, the information appears at the top of the screen.

Front panel display information

Limited disc information also appears in the front panel display. Press **DISPLAY (SHIFT + 8)** to change the displayed information.

- DVD / DVD-RW displays

2 · 2 8' 49" Disc no.
Chapter no.
Elapsed title time

2 · T · 1 1 07' 00" Disc no.
Title no.
Remaining title time

2 · 2 0' 42" Disc no.
Chapter no.
Remaining chapter time

- CD and Video CD displays

1 · 4 · 1' 16" Disc no.
Track no.
Elapsed track time

1 · 4 · 3' 20" Disc no.
Track no.
Remaining track time

1 · D s c · 53' 15" Disc no.
Remaining disc time

- WMA/MP3 disc displays

4 · 2 · 0' 35" Disc no.
Track no.
Elapsed track time

4 · E V E R Y B O D Disc no.
Track name

4 · B E S T _ O F _ Disc no.
Folder name

- JPEG disc displays

2 · T I G E R _ 0 1 Disc no.
File name

2 · Z O O _ T R I P Disc no.
Folder name

Chapter 7

Viewing JPEG discs

Playing a JPEG slideshow

After loading a CD/CD-R/RW containing JPEG pictures, press ► (play) to start a slideshow from the first folder/picture on the disc. The pictures in each folder are displayed in alphabetical order.

Pictures are automatically adjusted so that they fill as much of the screen as possible (if the aspect ratio of the picture is different to your TV screen you may notice black bars at the sides, or at the top and bottom of the screen).

While the slideshow is running:

Button	What it does
II	Pauses the slideshow; press again to restart.
◀◀	Displays the previous picture. Use with SHIFT to jump to the first file in the previous folder.
▶▶	Displays the next picture. Use with SHIFT to jump to the first file in the next folder.
ANGLE	Pauses the slideshow and rotates the currently displayed picture 90° clockwise. Press ► (play) to restart slideshow.
ZOOM	Pauses the slideshow and zooms the screen (see below). Press ► (play) to restart slideshow.
DVD MENU	Displays the Disc Navigator screen (see below).
FOLDER +/ FOLDER -	Skips to the next/previous folder when playing a JPEG disc.



Note

- The **II** (pause), **ANGLE** and **ZOOM** buttons do not work while the display shows **LOADING**.
- The time it takes for a file to load increases with large file sizes.
- Up to 999 files are viewable on a disc. If there are more files than this on a disc, only the first 999 files are viewable.
- If you want to play the WMA/MP3 tracks on a disc that also contains JPEG picture files, you should first set the **Photoviewer** option to **Off**. See *Options* on page 65.

Using the JPEG Disc Navigator and Photo Browser

Use the JPEG Disc Navigator to find a particular folder or picture by filename on the disc in the play position; use the Photo Browser to find a picture within a folder by thumbnail image.

1 Press DVD MENU to display the Disc Navigator screen.

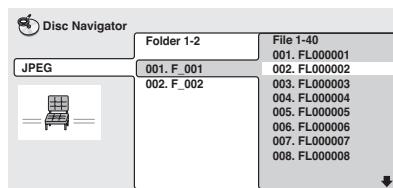

The left column shows the folders on the disc, the right column shows the files in a folder.

2 Use the cursor buttons (↑/↓/←/→) to navigate.

When a file is highlighted, a thumbnail image is displayed.

- When a folder is highlighted you can press **ENTER** to open the Photo Browser screen for that folder. See below for more on using the Photo Browser.

3 To resume the slideshow from the highlighted file, press **ENTER**.

Using the Photo Browser

The Photo Browser displays nine thumbnail images at a time from the current folder.

1 From the Disc Navigator screen, highlight a folder to display then press **ENTER**.

The Photo Browser screen opens with the first nine pictures displayed as thumbnails.

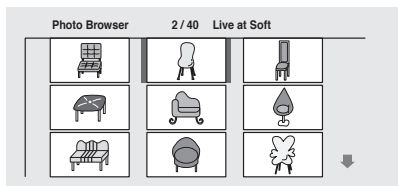

2 Use the cursor buttons (↑/↓/←/→) to highlight a thumbnail picture.

- Use the track skip buttons (◀◀ and ▶▶) to see the previous / next page of thumbnails. Keep the button pressed if you want to skip several pages; release when you reach the page you want.
- To return to the Disc Navigator screen, press **RETURN**.

3 Press **ENTER** to display the selected thumbnail full size on screen.

The slideshow resumes from the selected picture.

Zooming the screen

Using the zoom feature you can magnify a part of the screen by a factor of 2 or 4, while viewing pictures from a JPEG disc.

1 During slideshow playback, use the **ZOOM** button to select the zoom factor.

- **Normal**
- **2x**
- **4x**

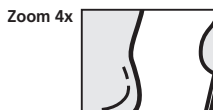
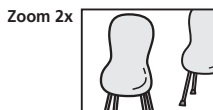
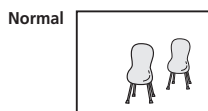

- The slideshow is paused when the screen is zoomed.
- Since JPEG pictures have a fixed resolution, picture quality may deteriorate, especially at 4x zoom. This is not a malfunction.

2 Use the cursor buttons (↑/↓/←/→) to change the zoomed area.

You can change the zoom factor and the zoomed area freely.

3 To resume the slideshow, press ► (play).

Chapter 8

Using the timer

Setting the wake-up timer

Use the wake-up timer to set the system to switch on at any time and start playing whatever source you want.



Important

- The clock must be set to the correct time for the wake-up timer to work properly (see *Setting the clock* on page 27).



1 Select the source you want played.

For example, press **TUNER** (**TUNER FM/AM/ST.** on the front panel) to select the radio as your source.

2 Prepare the source.

For example, tune in the radio station you want to wake up to.

3 Set the volume.

4 Press **TIMER** (**SHIFT + 6**) twice to reach the timer menu.

5 Use the **←/→** (cursor left/right) buttons to select 'Wake-Up?' then press **ENTER**.

6 Use the **←/→** (cursor left/right) buttons to select 'Timer Edit?' then press **ENTER**.

7 Set the switch-on time.

Use the **↑/↓** (cursor up/down) buttons to set the hour, then press **ENTER**. Set the minute in the same way, pressing **ENTER** when you're done.

8 Set the switch-off time.

Use the **↑/↓** (cursor up/down) buttons to set the hour, then press **ENTER**. Set the minute in the same way, pressing **ENTER** when you're done.

After pressing **ENTER** this last time, the wake-up indicator lights, and the switch-on, switch-off times, the function (**DVD/CD**, etc.) and volume are confirmed in the display.

9 Switch the system into standby mode.

The wake-up timer will not work if the system is left on!

**Tip**

- You can check the timer settings in standby by pressing **TIMER (SHIFT + 6)** twice. (Press **TIMER (SHIFT + 6)** once to display the current time.)

Turning the wake-up timer on/off

If the wake-up timer is on, it will switch on the system everyday at the time you have set.

- 1 Press **TIMER (SHIFT + 6)** twice to reach the timer menu.
- 2 Use the **←/→** (cursor left/right) buttons to select 'Wake-Up?' then press **ENTER**.
- 3 Use the **←/→** (cursor left/right) buttons to select 'Timer On?' or 'Timer Off?'.
 - You must have the timer set (see above) to select **On**. The wake-up timer switches on and off according to your previous settings.
- 4 Press **ENTER**.

**Note**

- The wake-up timer will automatically be canceled if the clock is reset.

Setting the sleep timer

The sleep timer switches off the system after a specified time so you can fall asleep without worrying about it.

**Important**

- If you set the sleep timer while either the wake-up timer is active, the earlier switch off time takes priority.

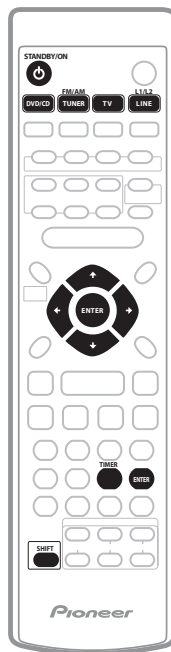

- 1 Press TIMER (SHIFT + 6) twice to reach the timer menu.**
- 2 Use the ←/→ (cursor left/right) buttons to select 'Sleep?' then press ENTER.**
- 3 Use the ↑/↓ (cursor up/down) buttons to select a switch-off time then press ENTER.**

Choose between the following options:

- **Sleep Auto** – Available only in CD mode; the system switches off automatically after the currently playing disc has finished.
 - **Sleep 90** – System switches off after 90 minutes
 - **Sleep 60** – System switches off after an hour
 - **Sleep 30** – System switches off after 30 minutes
 - **Off** – cancels the sleep timer
- 4 To check how much time is left, repeat steps 1 and 2.**

The remaining time is displayed momentarily.

Chapter 9

Surround sound and other settings

Using the System Setup menu

All the available settings in the setup menu are listed in *Surround and sound setup options* and *SR+ control options for Pioneer plasma displays* below. See the notes in each section for additional information about the settings. Follow the steps below to customize the settings in the System Setup menu.

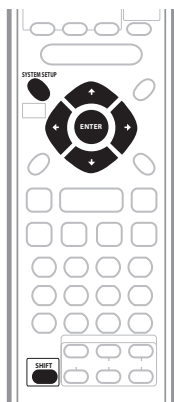

1 Press SYSTEM SETUP (SHIFT + HOME MENU).

2 Use the ←/→ (cursor left/right) buttons to choose the setting you want to adjust.

The current setting is shown for each option as you cycle through the display. See below for a full list and description of each.

3 Use the ↑/↓ (cursor up/down) buttons to adjust the setting.

4 Repeat steps 2 and 3 to make other settings.

5 When you're done, press ENTER to leave the System Setup menu.



Note

- The System Setup menu is exited automatically after 5 minutes of inactivity.
- You can't make these settings with the Recording Mode (page 72) switched on.

Surround and sound setup options

The Room Setup feature (page 27) is designed to give you a basic surround sound setup, however you can make more detailed settings that may improve the surround sound in your listening room. Note that the first setting in each section is the default.

Front speakers distance setting

Specifies the distance from your listening position to the front speakers:

- **Front 1 ft. ~ Front 30 ft.** – Distance can be set in increments of 1 ft. The default is 10 ft.

Center speaker distance setting

Specifies the distance from your listening position to the center speaker:

- **Center 1 ft. ~ Center 30 ft.** – Distance can be set in increments of 1 ft. The default is 10 ft.

Surround speakers distance setting

Specifies the distance from your listening position to the surround speakers:

- **Surr. 1 ft. ~ Surr. 30 ft.** – Distance can be set in increments of 1 ft. The default is 10 ft.

Dynamic Range Control

Specifies the amount of dynamic range adjustment to Dolby Digital or DTS soundtracks:

- **DRC Off** – No dynamic range adjustment (use when listening at higher volume)
- **DRC Mid.** – Mid setting
- **DRC High** – Dynamic range is reduced (loud sounds are reduced in volume while quieter sounds are increased)



Note

- This setting works only with Dolby Digital and some DTS soundtracks. For other sources you can create a similar effect using the Midnight mode (see *Using Quiet and Midnight listening modes* on page 41).

Dual mono setting

Specifies how dual mono encoded Dolby Digital or DTS soundtracks should be played. You can also use this setting to switch the audio channel on DVD-RW discs recorded with two separate soundtracks.

- **L-Ch1 R-Ch2** – Both channels are played through the front speakers
- **Ch1 Mono** – Only channel 1 is played
- **Ch2 Mono** – Only channel 2 is played



Note

- On the **Ch1 Mono** and **Ch2 Mono** settings the sound comes only from the center speaker (or from the front speakers if listening in **STEREO** mode).
- This setting works only with dual mono encoded Dolby Digital or DTS soundtracks. See the disc packaging for channel information.

LFE attenuator setting

Dolby Digital and DTS audio sources include ultra-low bass tones. Set the LFE attenuator as needed to prevent the ultra-low bass from distorting the sound.

- **LFE ATT 0** – The LFE channel is played with no attenuation
- **LFE ATT 10** – LFE channel is attenuated by 10dB
- **LFE Off** – LFE channel is not played

SR+ control options for Pioneer plasma displays

Make the following settings if you have connected a Pioneer plasma display to this unit using an SR+ cable (not supplied).

Note that in the function settings below, the number of video inputs may change depending on your display. See also *Using this unit with a Pioneer plasma display* on page 16.

Control mode setting

- **SR+ Off** – Switches SR+ off (this unit and the plasma display work independently)
- **SR+ On** – Switches SR+ on (this unit sends control signals to the plasma display)

The following settings are only available if the Control mode setting (above) is switched on.

Volume control setting

- **Vol C.Off** – This unit does not control the volume of the plasma display
- **Vol C.On** – When this unit is switched to an input that used the plasma display (DVD, for example), the volume on the plasma display is muted so only sound from this unit is heard.

Function setting for DVD input

- **DVD -> OFF/PDP1-5/PDPTV** – Matches the **DVD** function of this unit with a numbered video input on the plasma display. For example, **DVD -> PDP2** matches the **DVD** input with video input 2 on the plasma display.

Function setting for TV input

- **TV -> OFF/PDP1-5/PDPTV** – Matches the **TV** function of this unit with a numbered video input on the plasma display. For example, **TV -> PDP1** matches the **TV** input with video input 1 on the plasma display.

Function setting for L1 input

- **LINE1 -> OFF/PDP1-5/PDPTV** – Matches the **LINE (L1)** function of this unit with a numbered video input on the plasma display. For example, **LINE1 -> PDP3** matches the **LINE1** input with video input 3 on the plasma display.

Function setting for L2 input

- **LINE2 -> OFF/PDP1-5/PDPTV** – Matches the **LINE (L2)** function of this unit with a numbered video input on the plasma display. For example, **LINE2 -> PDP3** matches the **LINE2** input with video input 3 on the plasma display.

Setting the channel levels

You can set the relative channel levels from your main listening position for all of the listening modes independently (except **STEREO**).

If you used the Room Setup feature (page 27), the channel levels for each listening mode will already be set. However, you can still fine-tune the levels here if you need to.

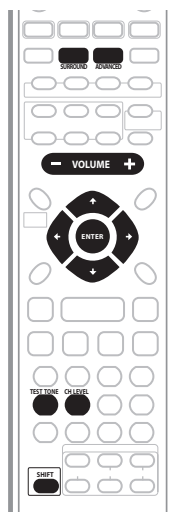

1 Select a listening mode.

Press **SURROUND**, **ADVANCED** or **FRONT SURROUND** repeatedly to select the listening mode you want.

2 Press **TEST TONE (SHIFT + 4)** to hear the test tone.

The test tone is output in the following order (from the speakers active in the current listening mode):

- **L** – Front left speaker
- **C** – Center speaker
- **R** – Front right speaker
- **RS** – Right surround speaker

- **LS** – Left surround speaker
- **SW** – Subwoofer

3 Use the **VOLUME +/-** button to adjust the volume to an appropriate level.

Turn down the volume to **-40dB** or less to ensure you have adequate headroom.

4 Use the **↑/↓ (cursor up/down)** buttons to adjust the speaker levels in turn.

You should hear the test tone at the same volume from each speaker when seated in the main listening position. The channel level range is ± 10 dB.

5 When you're done, press **ENTER** to exit test tone setup.



Tip

- The speaker volume can be adjusted while listening to any sound source you want by pressing **CH LEVEL (SHIFT + 5)** and then using the **↑/↓ (cursor up/down)** buttons to adjust the channel levels. After you're finished with one channel, use the **←/→ (cursor left/right)** buttons to move to the next.



Note

- When the **AUTO** listening mode is selected, using the test tone method will adjust levels for multichannel sources only. Use **CH LEVEL (SHIFT + 5)** and the **↑/↓ (cursor up/down)** buttons (see tip above) to set levels for the **AUTO** listening mode with two channel sources.
- Since the subwoofer produces ultra-low frequencies its sound may seem quieter than it actually is.

Chapter 10

Video Adjust menu

Video Adjust

- Default setting: **Standard**

From the Video Adjust screen you can select the standard video presentation or define presets of your own.

- 1 Press **HOME MENU** and select 'Video Adjust' from the on-screen display.



- 2 Use the **←/→** (cursor left/right) buttons to select a preset.

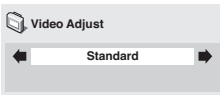

- **Standard**
- **Memory1–2** – Use for saving your own presets (see below)

- 3 Press **ENTER** to make the setting and exit the Video Adjust screen.

Note

- Depending on the disc and the TV/monitor, you may not see the effect clearly.

Creating your own presets

You can create up to two presets of your own.

- 1 Select one of the Memory presets (see above).

- 2 Press **↓** (cursor down) to select 'Detailed Settings' then press **ENTER**.

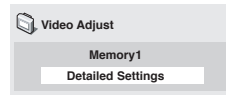

- 3 Adjust the picture quality settings.

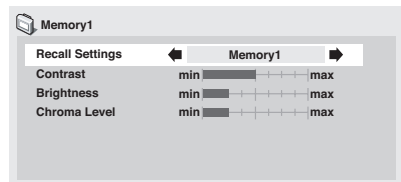

- Use the **↑/↓** (cursor up/down) buttons to select a setting.
- Use the **←/→** (cursor left/right) buttons to adjust the current setting.
- Press **DISPLAY (SHIFT + 8)** to switch between full and single view.
- You can switch between preset numbers in the **Recall Settings** menu item.

You can adjust any or all of the following picture quality settings:

- **Contrast** – Adjusts the contrast between light and dark.
- **Brightness** – Adjusts the overall brightness.
- **Chroma Level** – Adjusts how saturated colors appear.

- 4 Press **ENTER** to save the preset and exit the Video Adjust screen.

Chapter 11

Initial Settings menu

Using the Initial Settings menu

The Initial Settings menu gives you complete control in setting up your DVD system, including video output settings and parental lock settings, among others.

If an option is grayed out it means that it cannot be changed at the current time. This is usually because a disc is playing. Stop the disc, then change the setting.

1 Press HOME MENU and select 'Initial Settings' from the on-screen display.



2 Use the cursor buttons and ENTER to select the setting and option you want to set.

All the settings and options are explained on the following pages.



Note

- In the table below, the default setting is shown in **bold**; other settings are shown in *italics*.
- Some settings, such as **TV Screen**, **Audio Language** and **Subtitle Language** may be overridden by the DVD disc. Often these settings can also be made from the DVD disc menu.

Video Output settings

Setting	Option	What it means
TV Screen (See also <i>Screen sizes and disc formats</i> on page 77.)	4:3 (Letter Box)	Set if you have a conventional 4:3 TV. Widescreen movies are shown with black bars top and bottom.
	<i>4:3 (Pan & Scan)</i>	Set if you have a conventional 4:3 TV. Widescreen movies are shown with the sides cropped so that the image fills the screen.
	<i>16:9 (Wide)</i>	Set if you have a widescreen TV.
Component Out (See also <i>Connecting using the component video output</i> on page 14.)	Interlace	Set if your TV is not compatible with progressive scan video.
	<i>Progressive</i>	Set if your TV is compatible with progressive scan video (see your TV's instruction manual for details). Press ENTER once more to confirm (or RETURN to cancel). <i>Note that progressive scan video is only output from the component video jacks and that there is no output from the composite and S-video jacks when this setting is selected.</i>

Setting	Option	What it means
S-Video Out (See also <i>Connecting using the S-video output</i> on page 14.)	S2 <i>S1</i>	Standard setting. If you find that the picture is stretched or distorted on the default S2 setting, try changing it to this setting.

Language settings

Setting	Option	What it means
Audio Language	English	If there is an English soundtrack on the disc then it will be played.
	<i>Languages as displayed</i>	If there is the language selected on the disc, then it will be played.
	<i>Other Language</i>	Select to choose a language other than the ones displayed (see <i>Selecting languages using the language code list</i> on page 77).
Subtitle Language	English	If there is are English subtitles on the disc then they will be displayed.
	<i>Languages as displayed</i>	If there is the subtitle language selected on the disc, then it will be displayed.
	<i>Other Language</i>	Select to choose a language other than the ones displayed (see <i>Selecting languages using the language code list</i> on page 77).
DVD Menu Language	w/Subtitle Lang.	DVD disc menus will be displayed in the same language as your selected subtitle language, if possible.
	<i>Languages as displayed</i>	DVD disc menus will be displayed in the selected language, if possible.
	<i>Other Language</i>	Select to choose a language other than the ones displayed (see <i>Selecting languages using the language code list</i> on page 77).
Subtitle Display	On	Subtitles are displayed according to your selected subtitle language (see above).
	<i>Off</i>	Subtitles are always off by default when you play a DVD disc (note that some discs override this setting).

Display settings

Setting	Option	What it means
OSD Language	English	On-screen displays of the player are in English.
	<i>Languages as displayed</i>	On-screen displays are shown in the language selected.

Setting	Option	What it means
On Screen Display	On	Operation displays (Play , Resume , Scan , and so on) are shown on-screen.
	Off	Operation displays are not shown.
Angle Indicator	On	A camera icon is displayed on-screen during multi-angle scenes on a DVD disc.
	Off	No multi-angle indication is shown.

Options

Setting	Option	What it means
Parental Lock	See below	See <i>Parental Lock</i> below.
Photo Viewer	On	Only the JPEG files are shown on discs that contains both WMA/MP3 audio files and JPEG picture files.
	Off	WMA/MP3 audio file playback is possible.

Parental Lock

- Default level: **Off**; Default password: *none*;
Default Country code: **us (2119)**

To give you some control over what your children watch on your DVD player, some DVD-Video discs feature a Parental Lock level. If your player is set to a lower level than the disc, the disc won't play.

Some discs also support the Country Code feature. The player does not play certain scenes on these discs, depending on the Country Code you set.



Note

- Not all discs use Parental Lock, and will play without requiring the password first.
- If you forget your password, you'll need to reset the player to register a new password. (see *Resetting the system* on page 68)

Registering a new password

You must register a password before you can change the Parental Lock level or enter a Country code.

1 Select 'Password'.

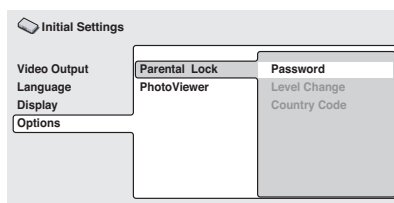

2 Use the number buttons to enter a 4-digit password.

The numbers you enter show up as asterisks (*) on-screen.

3 Press ENTER to register the password.

You will return to the **Options** menu screen.

Changing your password

To change your password, confirm your existing password then enter a new one.

- 1 **Select 'Password Change'.**
- 2 **Use the number buttons to enter your existing password, then press ENTER.**
- 3 **Enter a new password and press ENTER.**

This registers the new password and you will return to the Options menu screen.

Setting/changing the Parental Lock

- 1 **Select 'Level Change'.**
- 2 **Use number buttons to enter your password, then press ENTER.**
- 3 **Select a new level and press ENTER.**
 - Press ← (cursor left) repeatedly to lock more levels (more discs will require the password); press → (cursor right) to unlock levels. You can't lock level 1.

This sets the new level and you will return to the Options menu screen.

Setting/changing the Country code

You can find the *Country code list* on page 78.

- 1 **Select 'Country Code'.**
- 2 **Use number buttons to enter your password, then press ENTER.**
- 3 **Select a Country code and press ENTER.**

There are two ways you can do this:

- Select by code letter: Use ↑/↓ (cursor up/down) to change the Country code.
- Select by code number: Press → (cursor right) then use the number buttons to enter the 4-digit Country code.

- The new Country code is set and you will return to the Options menu screen. Note that the new Country code doesn't take effect until the next disc is loaded (or the current disc is reloaded).

Chapter 12

Additional information

Optional system settings

These settings are accessed by using the System Setup menu while in standby.

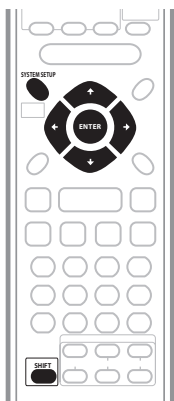

- 1 Switch the system into standby.
- 2 Press **SYSTEM SETUP (SHIFT + HOME MENU)**.
- 3 Use the **←/→ (cursor left/right)** buttons to choose the setting you want to adjust then press **ENTER**.
The current setting is shown for each option as you cycle through the display. See below for a full list and description of each.
- 4 Use the **↑/↓ (cursor up/down)** buttons to adjust the setting.
- 5 Repeat steps 2 and 3 to make other settings.
- 6 Press **ENTER** to confirm.

System Setup menu options in standby

Below are all the available settings in the setup menu. The first setting in each section is the default. See also the notes in each section for additional information about the settings.

Child lock setting

The Child Lock feature is useful when you've set the wake-up timer and don't want the system switched on before it activates.

- **Lock On** – Makes the front panel buttons and controls inoperative.
- **Lock Off** – Restores regular use of the front panel buttons and controls.

Clock format setting

Specifies how the clock is displayed:

- **12-Hour** – Sets the clock to show in 12-hour format in the display.
- **24-Hour** – Sets the clock to show in 24-hour format in the display.

TV attenuator setting

If the source connected to the **TV** analog input is producing distortion through the speakers, the attenuator will reduce the signal level.

- **ATT 6dB** – Reduces the signal level by 6dB.
- **ATT 10dB** – Reduces the signal level by 10dB.
- **ATT Off** – No attenuation

Line attenuator setting

If the source connected to the **LINE** analog input is distorting, the attenuator can reduce the signal level.

- **ATT 6dB** – Reduces the signal level by 6dB.

- **ATT 10dB** – Reduces the signal level by 10dB.
- **ATT Off** – No attenuation

Frequency step setting

If you find that you can't tune into stations successfully, the frequency step may not be suitable for your country/region.

- **FM 50. AM 9**
- **FM 100. AM 10**

System demo setting

Switches the automatic demo feature on or off (this starts when the system is plugged in for the first time):

- **Demo On** – Switches the demo feature on.
- **Demo Off** – Switches the demo feature off.





Note

- After setting the clock, the demo mode switches off automatically. However, if you unplug the system from the wall outlet, the demo mode will revert to **Demo On** (and the clock will be reset).

Resetting the system

Use this procedure to reset all system settings to the factory default.

- 1 **Switch the system into standby.**
- 2 **Press and hold the front panel  (stop) button for about 8 seconds until the display shows 'Mem.Clr.?'**
- 3 **Press the front panel /II button.**
All the system's settings are now reset, and you should see the 'Let's Get Started' screen.

Using and taking care of discs

Titles, chapters and tracks

DVD discs are generally divided into one or more titles. Titles may be further subdivided into chapters.

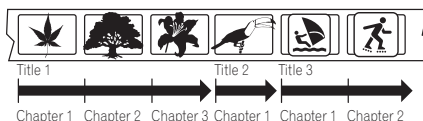

CDs and Video CDs are divided into tracks.

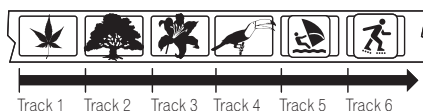

CD-ROMs contain folders and files. WMA/MP3 files are referred to as tracks. Folders may contain further folders.

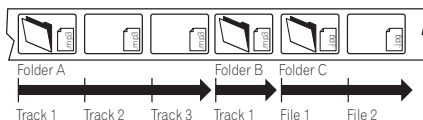

DVD Video regions

All DVD Video discs carry a region mark on the case somewhere that indicates which region(s) of the world the disc is compatible with. Your DVD system also has a region mark, which you can find on the rear panel. Discs from incompatible regions will not play in this system. Discs marked **ALL** will play in any system.

The diagram below shows the various DVD regions of the world.



Handling discs

When holding discs of any type, take care not to leave fingerprints, dirt or scratches on the disc surface. Hold the disc by its edge or by the center hole and edge.

Damaged or dirty discs can affect playback performance. Take care also not to scratch the label side of the disc. Although not as fragile as the recorded side, scratches can still result in a disc becoming unusable.

Should a disc become marked with fingerprints, dust, etc., clean using a soft, dry cloth, wiping the disc lightly from the center to the outside edge as shown in the diagram below.

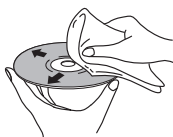

Wipe lightly from the center of the disc using straight strokes.



Don't wipe the disc surface using circular strokes.

If necessary, use a cloth soaked in alcohol, or a commercially available CD/DVD cleaning kit to clean a disc more thoroughly. Never use benzene, thinner or other cleaning agents, including products designed for cleaning vinyl records.

Storing discs

Although CDs and DVD discs are more durable than vinyl records, you should still take care to handle and store discs correctly. When you're not using a disc, return it to its case and store upright. Avoid leaving discs in excessively cold, humid, or hot environments (including under direct sunlight).

Don't glue paper or put stickers onto the disc, or use a pencil, ball-point pen or other sharp-tipped writing instrument. These could all damage the disc.



For more detailed care information see the instructions that come with discs.

Do not load more than one disc into the player at a time.

Discs to avoid

Discs spin at high speed inside the player. If you can see that a disc is cracked, chipped, warped, or otherwise damaged, don't risk using it—you could end up damaging the player.

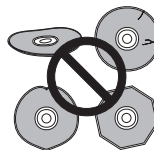

This system is designed for use with conventional, fully circular discs only. Use of shaped discs is not recommended for this product. Pioneer disclaims all liability arising in connection with the use of shaped discs.

Proper installation and maintenance of this system

Hints on installation

We want you to enjoy using this system for years to come, so please bear in mind the following points when choosing a suitable location for it:

Do...

- ✓ Use in a well-ventilated room.
- ✓ Place on a solid, flat, level surface, such as a table, shelf or stereo rack.

Don't...

- ✗ Use in a place exposed to high temperatures or humidity, including near radiators and other heat-generating appliances.
- ✗ Place on a window sill or other place where the system will be exposed to direct sunlight.
- ✗ Use in an excessively dusty or damp environment.
- ✗ Place directly on top of an amplifier, or other component in your stereo system that becomes hot in use.
- ✗ Use near a television or monitor as you may experience interference—especially if the television uses an indoor antenna.
- ✗ Use in a kitchen or other room where the system may be exposed to smoke or steam.
- ✗ Use on a thick rug or carpet, or cover with cloth—this may prevent proper cooling of the system unit.

- ✗ Place on an unstable surface, or one that is not large enough to support all four of the system unit's feet.

Cleaning the pickup lens

The DVD player's lens should not become dirty in normal use, but if for some reason it should malfunction due to dust or dirt, consult your nearest Pioneer authorized service center. Although lens cleaners are commercially available, we do not recommend using them since some may damage the lens.

Problems with condensation

Condensation may form inside the system unit if it is brought into a warm room from outside, or if the temperature of the room rises quickly. Although the condensation won't damage the system, it may temporarily impair its performance. For this reason you should leave it to adjust to the warmer temperature for about an hour before switching on and using.

Moving the system unit

If you need to move the main unit, first remove all discs, then press  **STANDBY/ON** on the front panel to turn the system off. Wait for **Good Bye** to disappear from the display, then unplug the power cord. Never lift or move the system during playback—discs rotate at a high speed and may be damaged.



Note

- Unplugging the system before **Good Bye** disappears from the display may cause the system to return to the factory settings.

Power cord caution

Handle the power cord by the plug part. Do not pull out the plug by tugging the cord, and never touch the power cord when your hands are wet, as this could cause a short circuit or

electric shock. Do not place the system unit, a piece of furniture, or other object on the power cord or pinch the cord in any other way. Never make a knot in the cord or tie it with other cords. The power cord should be routed so that they are not likely to be stepped on. A damaged power cord can cause a fire or give you an electric shock. Check the power cord once in a while. If you find it damaged, ask your nearest Pioneer authorized service center or your dealer for a replacement.

Connecting external antennas

External AM antenna

Use 5–6 meters (15–18 feet) of vinyl-insulated wire and set up either indoors or outdoors. Leave the AM loop antenna connected.

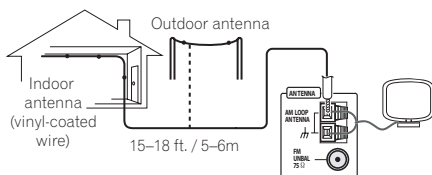

External FM antenna

Use 75Ω coaxial cable to hook up an external FM antenna.

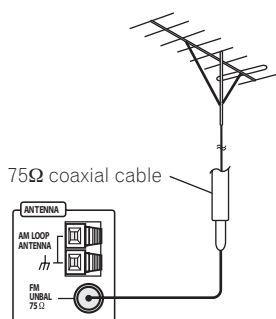

Connecting auxiliary components

This system has both stereo analog inputs and outputs, as well as a coaxial digital input. Use these to connect external components, such as your VCR, MD or CD-R recorder.

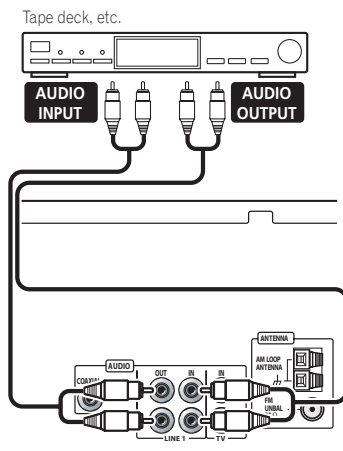

- **Connect the LINE 1 (IN) jacks to the analog outputs of an external playback component.**

These include components such as a VCR or cassette deck. Connect using RCA pin-plug stereo cables.

- **Connect the LINE 1 (OUT) jacks to the analog inputs of an external recording component.**

These include components such as a cassette deck, VCR, MD or another recorder with analog inputs. Connect using RCA pin-plug stereo cables.

- **Connect the COAX IN (LINE 2) jack on the rear panel to the coaxial digital output of an external playback component.**

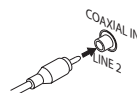

These include digital components such as an MD player, digital satellite, or a game system. Connect using a coaxial digital cable (not supplied).



Tip

- If you find that the **LINE 1** audio is distorting when played through this system, you can set the input attenuator to reduce the input signal level. See *Optional system settings* on page 67 to do this.

Recording mode

The Recording mode allows you to make surround-compatible analog recordings from the **LINE 1 (OUT)** jacks. Dolby multichannel sources will be downmixed to stereo for improved playback with systems that can provide matrix-decoding (like Dolby ProLogic).

1 Press SOUND MODE.

2 Use the Use the ←/→ (cursor left/right) buttons to select 'Rec Mode?'.

3 Press ENTER.

4 Use the ↑/↓ (cursor up/down) buttons to select 'R.Mode On' or 'R.Mode Off'.

- **R.Mode On** – A surround-compatible downmix (left-total/right-total, or Lt/Rt) of Dolby multichannel sources is output, (suitable for Dolby Surround Pro Logic or other matrix decoding).
- **R.Mode Off** – A simple stereo downmix (left-only/right-only, or Lo/Ro) is output (suitable for playback on a two-channel stereo system or on headphones).



Note

- When Recording mode is on, most surround sound-related functions cannot be used. The display will briefly blink **RecMode On** if you try and use a prohibited function while Recording mode is on.
- When Recording mode is off, the audio from the analog output may be interrupted, depending on the operation.
- The Recording mode automatically switches off if you change the input function (**DVD/CD, TUNER**, etc.) or switch the power off.

Troubleshooting

Incorrect operations are often mistaken for trouble and malfunctions. If you think that there is something wrong with this component, check the points below. Sometimes the trouble may lie in another component. Investigate the other components and electrical appliances being used. If the trouble cannot be rectified even after exercising the checks listed below, ask your nearest Pioneer authorized service center or your dealer to carry out repair work.



Important

- If the system is not operating normally due to external effects such as static electricity, disconnect the power plug from the outlet and insert again to resume normal operation.

General

Problem	Remedy
The power does not turn on.	<ul style="list-style-type: none"> • Connect the power plug to the wall outlet. • Disconnect the power plug from the outlet, and insert again. • Make sure there are no loose strands of speaker wire touching the rear panel. This could cause the system to shut off automatically.
No sound is output when a function is selected.	<ul style="list-style-type: none"> • If you're using the line input, make sure the component is connected correctly (see <i>Connecting auxiliary components</i> on page 71). • Press MUTE on the remote control to turn muting off. • Adjust the VOLUME.
No image is output when playing discs.	<ul style="list-style-type: none"> • Make sure the TV is connected correctly (see <i>Connecting to your TV</i> on page 13). • Reset the video output to interlace (see <i>Watching progressive scan video from the component video outputs</i> on page 15).
No sound from surround or center speakers.	<ul style="list-style-type: none"> • Refer to <i>Setting the channel levels</i> on page 60 to check speaker levels. • Check that you haven't selected the STEREO sound mode (see <i>Listening in stereo</i> on page 40). • Make sure the speakers are connected properly (see <i>Connecting the speakers</i> on page 10).
Can't operate the remote control.	<ul style="list-style-type: none"> • Replace the batteries (see <i>Putting the batteries in the remote control</i> on page 7). • Operate within 23 ft. / 7 m, 30° of the remote sensor on the front panel (see <i>Using the remote control</i> on page 8). • Remove any obstacles or operate from another position. • Avoid exposing the remote sensor on the front panel to direct light. • You won't be able to use the remote sensor of this unit with the CONTROL IN jack of this unit connected to the CONTROL OUT jack of your plasma display. You can use the remote sensor of the plasma display (even in standby) as long as the power isn't switched off.

Problem	Remedy
Sound Demo shows in the display and the unit can't be controlled.	<ul style="list-style-type: none"> Press and hold ■ (stop) on the front panel for about five seconds. The disc tray ejects automatically to indicate the Sound Demo mode is disabled.
Timer indicator is blinking and the system will not switch on.	<ul style="list-style-type: none"> Unplug the system, then plug back in. Wait for one minute then switch on. Make sure the fan at the rear of the system unit is not being blocked. Check that the speakers are connected correctly. Make sure the voltage of the mains power source is correct for the model. If the problem persists, take it to your nearest Pioneer authorized service center or your dealer for servicing.

DVD/CD/Video CD player

Problem	Remedy
The disc is ejected automatically after loading.	<ul style="list-style-type: none"> Clean the disc. Align the disc properly in the disc guide. If the region number on a DVD-video disc does not match the number on the system unit, the disc cannot be used (see <i>DVD Video regions</i> on page 68). Allow time for any condensation inside the system unit to evaporate. Avoid using the system near an air-conditioning unit.
Playback is not possible.	<ul style="list-style-type: none"> If the disc is loaded upside down, reload the disc with the label side face up.
Picture playback stops and the operation buttons cannot be used.	<ul style="list-style-type: none"> Press ■ (stop), then ▶ (play) to start playback again. Switch the power off once, then on again using the front panel ⏻ STANDBY/ON button.
Settings are canceled.	<ul style="list-style-type: none"> When the power is cut due to power failure or by unplugging the power cord, settings will be canceled.
No picture/No color.	<ul style="list-style-type: none"> Check that connections are correct and that plugs are inserted fully. Check the instruction manual of the TV/monitor to make sure the TV/monitor settings are incorrect.
Screen is stretched or aspect does not change.	<ul style="list-style-type: none"> The TV Screen setting is incorrect. Set the TV Screen option to match the TV/monitor you're using (see <i>Video Output settings</i> on page 63).
CD won't play.	<ul style="list-style-type: none"> Set the PhotoViewer menu option in the Initial Settings menu to Off to be able to play some copy-protected CDs. See <i>Options</i> on page 65.

Problem	Remedy
When recorded on a VCR or passed through an AV selector, there is disturbance in the playback picture.	<ul style="list-style-type: none"> This system uses copy-protection technology which may prevent recording or cause picture problems when connected through a VCR or AV selector. This is not a malfunction.
Picture disturbance during playback or dark.	<ul style="list-style-type: none"> This system is compatible with Macro-Vision System copy guard. Some discs include a copy prevention signal, and when this type of disc is played back, stripes etc., may appear on some sections of the picture depending on the TV. This is not a malfunction. Discs respond differently to particular system functions. This may result in the screen becoming black for a brief instant or shaking slightly when the function is executed. These problems are largely due to differences between discs and disc content and are not malfunctions of this system.
Noticeable difference in DVD and CD volume.	<ul style="list-style-type: none"> DVDs and CDs use different recording methods. This is not a malfunction.

WMA/MP3/JPEG discs

Problem	Remedy
CD-ROM disc is not recognized by the system.	<ul style="list-style-type: none"> Make sure that the CD-ROM was recorded using the ISO 9660 disc format. See <i>Disc / content format playback compatibility</i> on page 8 for other disc compatibility information.
Files don't show up in the Disc Navigator/Photo Browser.	<ul style="list-style-type: none"> The files on the disc must be named with the correct file extension: .mp3 for MP3 files; .wma for WMA files; .jpg for JPEG files (upper or lower-case is OK). See <i>Disc / content format playback compatibility</i> on page 8 for other disc compatibility information.
Can play JPEG files, but not WMA/MP3 files on the same disc (or vice versa).	<ul style="list-style-type: none"> Set the PhotoViewer menu option in the Initial Settings menu to Off to be able to access the WMA/MP3 files. Set to On to be able to play the JPEG files. See <i>Options</i> on page 65.
Can't play WMA files.	<ul style="list-style-type: none"> The files were recorded using DRM (digital rights management). This is not a malfunction. See <i>DRM</i> in the <i>Glossary</i> on page 80.

Tuner

Problem	Remedy
Auto tuning does not pick up some stations.	<ul style="list-style-type: none"> The radio signal is weak. Auto tuning will only detect radio stations with a good signal. For more sensitive tuning, connect an outdoor antenna.

Problem	Remedy
Sound is mono only.	<ul style="list-style-type: none"> • Check that the tuner is not set to FM mono (see <i>Improving poor FM reception</i> on page 35).
Considerable noise in radio broadcasts.	<ul style="list-style-type: none"> • Tune into the correct frequency. • Connect the antenna (see <i>Connecting the supplied antennas</i> on page 18 and <i>Connecting external antennas</i> on page 71). • Fully extend the FM wire antenna, position for best reception, and secure to a wall. • Connect an outdoor FM antenna (see <i>Connecting external antennas</i> on page 71). • Adjust the direction and position for best reception. • Connect an additional internal or external AM antenna (see <i>AM loop antenna</i> on page 18 and <i>Connecting external antennas</i> on page 71). • Turn off any other equipment that may be causing the noise or move it away from the system unit. • The tuning interval is incorrect for your country or region. Try switching the tuning interval (frequency step) (see <i>TV attenuator setting</i> on page 67).

Error Messages

Message	Description
Child Lock	<ul style="list-style-type: none"> • This message appears when the front panel buttons are pressed when the child lock feature is active. See <i>Child lock setting</i> on page 67 for more on switching on/off the child lock.
Rec Mode On	<ul style="list-style-type: none"> • Blinks rapidly for 2 seconds when an operation is prohibited because the Recording Mode is on (see <i>Recording mode</i> on page 72).
Phones In	<ul style="list-style-type: none"> • Blinks rapidly for 2 seconds when an operation is prohibited because headphones are connected.
96k Stereo	<ul style="list-style-type: none"> • Blinks rapidly for 2 seconds when an operation is prohibited because the source is digital 88.2 or 96kHz PCM.
No Surr. SP	<ul style="list-style-type: none"> • Blinks rapidly for 2 seconds when an operation is prohibited because there is no surround speaker output.
Muting	<ul style="list-style-type: none"> • Blinks rapidly for 2 seconds when an operation is prohibited because the sound is muted (press the MUTE button to turn the sound on).
Exit	<ul style="list-style-type: none"> • Appears briefly when a menu is automatically exited after a set period of inactivity.
SR+ Error	<ul style="list-style-type: none"> • Appears when there is a communication problem between the unit and the plasma display. Check all connections and retry.

Screen sizes and disc formats

DVD-Video discs come in several different screen aspects, ranging from TV programs, which are generally 4:3, to CinemaScope widescreen movies, with an aspect ratio of up to about 7:3.

Televisions also come in different aspect ratios; 'standard' 4:3 and widescreen 16:9.

Widescreen TV users

If you have a widescreen TV, the **TV Screen** setting (page 63) of this system should be set to **16:9 (Wide)**.

When you watch discs recorded in 4:3 format, you can use the TV controls to select how the picture is presented. Your TV may offer various zoom and stretch options; see the instructions that came with your TV for details.

Please note that some movie aspect ratios are wider than 16:9, so even though you have a widescreen TV, these discs will still play in a 'letterbox' style with black bars at the top and bottom of the screen.

Standard TV users

If you have a standard TV, the TV Screen setting (page 63) of this system should be set to **4:3 (Letter Box)** or **4:3 (Pan&Scan)**, depending on which you prefer.

Set to **4:3 (Letter Box)**, widescreen discs are shown with black bars top and bottom.



Set to **4:3 (Pan&Scan)**, widescreen discs are shown with the left and right sides cropped. Although the picture looks larger, you don't actually see the whole picture.



Please note that many widescreen discs override the system's settings so that the disc is shown in letterbox format regardless of the setting.



Tip

- Using the **16:9 (Wide)** setting with a standard 4:3 TV, or either of the **4:3** settings with a widescreen TV, will result in a distorted picture.

Selecting languages using the language code list

Some of the language options allow you to set your preferred language from any of the 136 languages listed in the *Language code list* on page 78.

- 1 **Select 'Other Language'.**
- 2 **Use the ←/→ (cursor left/right) buttons to select either a code letter or a code number.**
- 3 **Use the ↑/↓ (cursor up/down) buttons to select a code letter or a code number.**
See *Language code list* on page 78 for a complete list of languages and codes.

Language code list

Language (Language code letter), **Language code**

Japanese (ja), 1001	Estonian (et), 0520	Lingala (ln), 1214	Slovak (sk), 1911
English (en), 0514	Basque (eu), 0521	Laothian (lo), 1215	Slovenian (sl), 1912
French (fr), 0618	Persian (fa), 0601	Lithuanian (lt), 1220	Samoan (sm), 1913
German (de), 0405	Finnish (fi), 0609	Latvian (lv), 1222	Shona (sn), 1914
Italian (it), 0920	Fiji (fj), 0610	Malagasy (mg), 1307	Somali (so), 1915
Spanish (es), 0519	Faroese (fo), 0615	Maori (mi), 1309	Albanian (sq), 1917
Dutch (nl), 1412	Frisian (fy), 0625	Macedonian (mk), 1311	Serbian (sr), 1918
Russian (ru), 1821	Irish (ga), 0701	Malayalam (ml), 1312	Siswati (ss), 1919
Chinese (zh), 2608	Scots-Gaelic (gd), 0704	Mongolian (mn), 1314	Sesotho (st), 1920
Korean (ko), 1115	Galician (gl), 0712	Moldavian (mo), 1315	Sundanese (su), 1921
Greek (el), 0512	Guarani (gn), 0714	Marathi (mr), 1318	Swedish (sv), 1922
Afar (aa), 0101	Gujarati (gu), 0721	Malay (ms), 1319	Swahili (sw), 1923
Abkhazian (ab), 0102	Hausa (ha), 0801	Maltese (mt), 1320	Tamil (ta), 2001
Afrikaans (af), 0106	Hindi (hi), 0809	Burmese (my), 1325	Telugu (te), 2005
Amharic (am), 0113	Croatian (hr), 0818	Nauru (na), 1401	Tajik (tg), 2007
Arabic (ar), 0118	Hungarian (hu), 0821	Nepali (ne), 1405	Thai (th), 2008
Assamese (as), 0119	Armenian (hy), 0825	Norwegian (no), 1415	Tigrinya (ti), 2009
Aymara (ay), 0125	Interlingua (ia), 0901	Occitan (oc), 1503	Turkmen (tk), 2011
Azerbaijani (az), 0126	Interlingue (ie), 0905	Oromo (om), 1513	Tagalog (tl), 2012
Bashkir (ba), 0201	Inupiak (ik), 0911	Oriya (or), 1518	Setswana (tn), 2014
Byelorussian (be), 0205	Indonesian (in), 0914	Panjabi (pa), 1601	Tonga (to), 2015
Bulgarian (bg), 0207	Icelandic (is), 0919	Polish (pl), 1612	Turkish (tr), 2018
Bihari (bh), 0208	Hebrew (iw), 0923	Pashto, Pushto (ps), 1619	Tsonga (ts), 2019
Bislama (bi), 0209	Yiddish (ji), 1009	Portuguese (pt), 1620	Tatar (tt), 2020
Bengali (bn), 0214	Javanese (jw), 1023	Quechua (qu), 1721	Twi (tw), 2023
Tibetan (bo), 0215	Georgian (ka), 1101	Rhaeto-Romance (rm), 1813	Ukrainian (uk), 2111
Breton (br), 0218	Kazakh (kk), 1111	Kirundi (rn), 1814	Urdu (ur), 2118
Catalan (ca), 0301	Greenlandic (kl), 1112	Romanian (ro), 1815	Uzbek (uz), 2126
Corsican (co), 0315	Cambodian (km), 1113	Kinyarwanda (rw), 1823	Vietnamese (vi), 2209
Czech (cs), 0319	Kannada (kn), 1114	Sanskrit (sa), 1901	Volapük (vo), 2215
Welsh (cy), 0325	Kashmiri (ks), 1119	Sindhi (sd), 1904	Wolof (wo), 2315
Danish (da), 0401	Kurdish (ku), 1121	Sangho (sg), 1907	Xhosa (xh), 2408
Bhutanese (dz), 0426	Kirghiz (ky), 1125	Serbo-Croatian (sh), 1908	Yoruba (yo), 2515
Esperanto (eo), 0515	Latin (la), 1201	Sinhalese (si), 1909	Zulu (zu), 2621

Country code list

Country, Country code, **Country code letter**

Argentina, 0118, ar	Hong Kong, 0811, hk	Philippines, 1608, ph
Australia, 0121, au	India, 0914, in	Portugal, 1620, pt
Austria, 0120, at	Indonesia, 0904, id	Russian Federation, 1821, ru
Belgium, 0205, be	Italy, 0920, it	Singapore, 1907, sg
Brazil, 0218, br	Japan, 1016, jp	Spain, 0519, es
Canada, 0301, ca	Korea, Republic of, 1118, kr	Switzerland, 0308, ch
Chile, 0312, cl	Malaysia, 1325, my	Sweden, 1905, se
China, 0314, cn	Mexico, 1324, mx	Taiwan, 2023, tw
Denmark, 0411, dk	Netherlands, 1412, nl	Thailand, 2008, th
Finland, 0609, fi	New Zealand, 1426, nz	United Kingdom, 0702, gb
France, 0618, fr	Norway, 1415, no	United States of America, 2119, us
Germany, 0405, de	Pakistan, 1611, pk	

Preset code list

Please note that there are cases where only certain functions may be controllable after assigning the proper preset code, or the codes for the manufacturer in the list will not work for the model that you are using.

ACURA 644	FRONTECH/PROTECH 632	MANESTH 639, 646	SAMBERS 649
ADMIRAL 631	FUJITSU 648, 629	MARANTZ 607	SAMSUNG 607, 638, 644, 646
AIWA 660	FUNAI 640, 646, 658	MARK 607	SANYO 635, 645, 648, 621, 614
AKAI 632, 635, 642	GBC 632, 642	MATSUI 607, 639, 640, 642, 644, 647, 648	SBR 607, 634
AKURA 641	GE 601, 608, 607, 610, 617, 602, 628, 618	MEDIATOR 607	SCHAUB LORENZ 642
ALBA 607, 639, 641, 644	GEC 607, 634, 648	MEMOREX 644	SCHNEIDER 607, 641, 647
AMSTRAD 642, 644, 647	GELOSO 632, 644	METZ 631	SEG 642, 646
ANITECH 644	GENEXXA 631, 641	MINERVA 631, 653	MCMICHAEL 634
ASA 645	GOLDSTAR 610, 623, 621, 602, 607, 650	MITSUBISHI 609, 610, 602, 621, 631	SEI 632, 640, 649
ASUKA 641	GOODMANS 607, 639, 647, 648, 656	MULTITECH 644, 649	SELECO 631, 642
AUDIOGONIC 607, 636	GORENJE 638	NEC 659	SHARP 602, 619, 627
BASIC LINE 641, 644	GRAETZ 631, 642	NECKERMANN 631, 607	SIAREM 632, 649
BAUR 631, 607, 642	GRANADA 607, 635, 642, 643, 648	NEI 607, 642	SIEMENS 631
BEKO 638	GRADIENTE 630, 657	NIKKAI 605, 607, 641, 646, 648	SINUDYNE 632, 639, 640, 649
BEON 607	GRANDIN 618	NOBLIKO 649	SKANTIC 643
BLAUPUNKT 631	GRUNDIG 631, 653	NOKIA 632, 642, 652	SOLAVOX 631
BLUE SKY 641	HANSEATIC 607, 642	NORDMENDE 632, 636, 651, 652	SONOKO 607, 644
BLUE STAR 618	HCM 618, 644	OSAKI 641, 646, 648	SONOLOR 631, 635
BPL 618	HINARI 607, 641, 644	OSO 641	SONTEC 607
BRANDT 636	HISAWA 618	OSUME 648	SONY 604
BTC 641	HITACHI 631, 633, 634, 636, 642, 643, 654, 606, 610, 624, 625, 618	OTTO VERSAND 631, 632, 607, 642	SOUNDWAVE 607
BUSH 607, 641, 642, 644, 647, 656	HUANYU 656	PALLADIUM 638	STANDARD 641, 644
CASCADE 644	HYPSON 607, 618, 646	PANAMA 646	STERN 631
CATHAY 607	ICE 646, 647	PANASONIC 631, 607, 608, 642, 622	SUSUMU 641
CENTURION 607	IMPERIAL 638, 642	PATHO CINEMA 642	SYSLINE 607
CGB 642	INDIANA 607	PAUSA 644	TANDY 631, 641, 648
CIMLINE 644	INGELEN 631	PHILCO 632, 642	TASHIKO 634
CLARIVOX 607	INTERFUNK 631, 632, 607, 642	PHILIPS 631, 607, 634, 656	TATUNG 607, 648
CLATRONIC 638	INTERVISION 646, 649	PHOENIX 632	TEC 642
CONDOR 638	ISUKAI 641	PHONOLA 607	TELEAVIA 636
CONTEC 644	ITC 642	PROFEX 642, 644	TELEFUNKEN 636, 637, 652
CROSLEY 632	ITT 631, 632, 642	PROTECH 607, 642, 644, 646, 649	TELETECH 644
CROWN 638, 644	JEC 605	QUELLE 631, 632, 607, 642, 645, 653	TENSAI 640, 641
CRYSTAL 642	JVC 613, 623	R LINE 607	THOMSON 636, 651, 652, 663
CYBERTRON 641	KAISUI 618, 641, 644	RADIOLA 607	THORN 631, 607, 642, 645, 648
DAEWOO 607, 644, 656	KAPSCH 631	RADIOSHACK 610, 623, 621, 602	TOMASHI 618
DAINICHI 641	KENDO 642	RBM 653	TOSHIBA 605, 602, 626, 621, 653
DANSAI 607	KENNEDY 632, 642	RCA 601, 610, 615, 616, 617, 618, 661, 662, 609	TOWADA 642
DAYTON 644	KORPEL 607	REDIFFUSION 632, 642	ULTRAVOX 632, 642, 649
DECCA 607, 648	KOYODA 644	REX 631, 646	UNIVERSUM 631, 607, 638, 642, 645, 646, 654, 655
DIXI 607, 644	LEYCO 607, 640, 646, 648	ROADSTAR 641, 644, 646	VESTEL 607
DUMONT 653	LIESENKÄTTER 607	SABA 631, 636, 642, 651	VICTOR 613
ELIN 607	LOEWE 607	SAISHO 639, 644, 646	VOXSON 631
ELITE 641	LUXOR 632, 642, 643	SALORA 631, 632, 642, 643	WALTHAM 643
ELTA 644	M-ELECTRONIC 631, 644, 645, 654, 655, 656, 607, 636, 651		WATSON 607
EMERSON 642	MAGNADYNE 632, 649		WATT RADIO 632, 642, 649
ERRES 607	MAGNAFON 649		WHITE
FERGUSON 607, 636, 651	MAGNAVOX 607, 610, 603, 612, 629		WESTINGHOUSE 607
FINLANDIA 635, 643, 655			YOKO 607, 642, 646
FINLUX 632, 607, 645, 648, 653, 654, 655			ZENITH 603, 620
FIRSTLINE 640, 644			PIONEER 600, 631, 632, 607, 636, 642, 651
FISHER 632, 635, 638, 645			
FORMENTI 632, 607, 642			
FRONTECH 631, 642, 646			

Glossary

Analog audio Direct representation of sound by an electrical signal. See also *Digital audio*.

Aspect ratio The width of a TV screen relative to its height. Conventional TVs are 4:3; widescreen models are 16:9.

Digital audio Indirect representation of sound using numbers. See also *Sampling frequency* and *Analog audio*.

Dolby Digital A multichannel audio encoding system developed by Dolby Laboratories that enables far more audio to be stored on a disc than PCM encoding. See also *PCM (Pulse Code Modulation)*.



DRM DRM (digital rights management) is a technology designed to prevent unauthorized copying by restricting playback of material on devices other than the PC used to record it. For detailed information, please see the instruction manuals or help files that came with your PC and WMA recording software.

DTS A multichannel audio encoding system developed by Digital Theater Systems that enables far more audio to be stored on a disc than PCM encoding. See also *PCM (Pulse Code Modulation)*.



Dynamic range The difference between the quietest and loudest sounds possible in an audio signal.

EXIF (Exchangeable Image File) A file format developed by Fuji Photo Film for digital still cameras. Digital cameras from various manufacturers use this compressed file format which carries date, time and thumbnail information, as well as the picture data.

File extension A tag added to the end of a filename to indicate the type of file. For example, ".mp3" indicates an MP3 file.

ISO 9660 format International standard for the volume and file structure of CD-ROM discs.

JPEG A standard file format used for still images. JPEG files are identified by the file extension ".jpg".

MP3 MP3 (MPEG1 audio layer 3) is a compressed stereo audio file format. Files are recognized by their file extension ".mp3".

MPEG audio An audio format used on Video CDs and some DVD discs.

MPEG video A video format used on Video CDs and some DVD discs.

PBC (PlayBack Control) A system of navigating a Video CD through on-screen menus recorded onto the disc.

PCM (Pulse Code Modulation) Digital audio encoding system found on CDs. Good quality, but requires a lot of data compared to Dolby Digital, DTS and MPEG encoded audio. See also *Digital audio*.

Progressive scan video All the lines that make up a video picture are updated in one pass (compared to interlace which takes two passes to update the whole picture).

Regions These associate DVD-Video discs and players with particular areas of the world. See *DVD Video regions* on page 68 for more information.

Sampling frequency The rate at which sound is measured to be turned into digital audio data. The higher the rate, the better the sound quality. CD is 44.1 kHz; DVD can be up to 96 kHz. See also *Digital audio*.

WMA WMA is short for Windows Media Audio and refers to an audio compression technology developed by Microsoft Corporation. Files are recognized by their file extension ".wma".

Manufactured under license from Dolby Laboratories. "Dolby", "Pro Logic" and the double-D symbol are trademarks of Dolby Laboratories. "DTS" and "DTS Digital Surround" are registered trademarks of Digital Theater Systems, Inc.

Specifications

Amplifier section

Continuous Power Output (RMS):
 Front, center, surround 100 W per channel
 (1 kHz, 10 % T.H.D., 6 Ω)
 Subwoofer 100 W (100 Hz, 10 % T.H.D., 6 Ω)

FM tuner section

Frequency range 87.5 – 108 MHz
 Antenna 75 Ω, unbalanced

AM tuner section

Frequency range
 With 9 kHz step 531 kHz to 1,602 kHz
 With 10 kHz step 530 kHz to 1,700 kHz
 Antenna Loop antenna

Miscellaneous

Power requirements AC 120 V, 60 Hz
 Power consumption 180 W
 Power consumption in standby 0.5 W
 Dimensions 420 (W) x 126 (H) x 445 (D) mm/
 16 9/16 (W) x 4 15/16 (H) x 17 1/2 (D) in.
 Weight 9.8 kg / 21 lb, 10 oz

Accessories (DVD/CD receiver)

Remote control 1
 AA/R6P dry cell batteries 2
 Video cable (yellow plugs) 1
 AM loop antenna 1
 FM antenna 1
 Power cord 1
 These operating instructions 1
 Warranty Card 1

Speaker System (S-HTD340)

(Front speakers x2, surround speakers x2, center speaker x1, subwoofer x1)

Front speakers

Enclosure Closed-box bookshelf type
 (magnetically shielded)
 System 2-way system

Speakers

Woofer 10 cm cone type
 Tweeter 3.2 cm semi-dome type
 Nominal impedance 6 Ω
 Frequency range 60 Hz to 20 kHz
 Maximum Input Power 100 W
 Dimensions 155 (W) x 360 (H) x 177 (D) mm/
 6 1/8 (W) x 14 3/16 (H) x 6 15/16 (D) in.
 Weight 2.4 kg / 5 lb 5 oz

Center speaker

Enclosure Closed-box bookshelf type
 (magnetically shielded)
 System 8.7 cm 1-way system
 Speakers 8.7 cm cone type
 Nominal impedance 6 Ω
 Frequency range 65 Hz to 20 kHz
 Maximum Input Power 100 W
 Dimensions 350 (W) x 116 (H) x 98 (D) mm/
 13 3/4 (W) x 4 9/16 (H) x 3 7/8 (D) in.
 Weight 1.6 kg / 3 lb 8 oz

Surround speakers

Enclosure Closed-box bookshelf type
 (magnetically shielded)
 System 8.7 cm 1-way system
 Speakers 8.7 cm cone type
 Nominal impedance 6 Ω
 Frequency range 85 Hz to 20 kHz
 Maximum Input Power 100 W
 Dimensions 155 (W) x 116 (H) x 98 (D) mm/
 6 1/8 (W) x 4 9/16 (H) x 3 7/8 (D) in.
 Weight 1 kg / 2 lb 3 oz

Subwoofer

Enclosure	Bass-reflex floor type
System	16 cm 1-way system
Speaker	16 cm cone type
Nominal impedance	6 Ω
Frequency range	35 Hz to 2 kHz
Maximum Input Power	100 W
Dimensions	190 (W) x 360 (H) x 327 (D) mm/ 7 1/2 (W) x 14 3/16 (H) x 12 7/8 (D) in.
Weight	5.0 kg / 11 lb 0 oz

Accessories (Speaker system)

Speaker cables	6
Non-skid pads	1 sheet

**Note**

- This product includes FontAvenue® fonts licensed by NEC corporation. FontAvenue is a registered trademark of NEC Corporation.
- Specifications and design subject to possible modification without notice, due to improvements.

Published by Pioneer Corporation
 Copyright ©2004 Pioneer Corporation
 All rights reserved



Dear Customer:

Selecting fine audio equipment such as the unit you've just purchased is only the start of your musical enjoyment. Now it's time to consider how you can maximize the fun and excitement your equipment offers. This manufacturer and the Electronic Industries Association's Consumer Electronics Group want you to get the most out of your equipment by playing it at a safe level. One that lets the sound come through loud and clear without annoying blaring or distortion—and, most importantly, without affecting your sensitive hearing.

Sound can be deceiving. Over time your hearing "comfort level" adapts to higher volumes of sound. So what sounds "normal" can actually be loud and harmful to your hearing. Guard against this by setting your equipment at a safe level BEFORE your hearing adapts.

To establish a safe level:

- Start your volume control at a low setting.
- Slowly increase the sound until you can hear it comfortably and clearly, and without distortion.

Once you have established a comfortable sound level:

- Set the dial and leave it there.

Taking a minute to do this now will help to prevent hearing damage or loss in the future. After all, we want you listening for a lifetime.

We Want You Listening For A Lifetime

Used wisely, your new sound equipment will provide a lifetime of fun and enjoyment. Since hearing damage from loud noise is often undetectable until it is too late, this manufacturer and the Electronic Industries Association's Consumer Electronics Group recommend you avoid prolonged exposure to excessive noise. This list of sound levels is included for your protection.

Decibel

<u>Level</u>	<u>Example</u>
30	Quiet library, soft whispers
40	Living room, refrigerator, bedroom away from traffic
50	Light traffic, normal conversation, quiet office
60	Air conditioner at 20 feet, sewing machine
70	Vacuum cleaner, hair dryer, noisy restaurant
80	Average city traffic, garbage disposals, alarm clock at two feet.

THE FOLLOWING NOISES CAN BE DANGEROUS UNDER CONSTANT EXPOSURE

90	Subway, motorcycle, truck traffic, lawn mower
100	Garbage truck, chain saw, pneumatic drill
120	Rock band concert in front of speakers, thunderclap
140	Gunshot blast, jet plane
180	Rocket launching pad

Information courtesy of the Deafness Research Foundation.



S001A_en

Should this product require service in the U.S.A. and you wish to locate the nearest Pioneer Authorized Independent Service Company, or if you wish to purchase replacement parts, operating instructions, service manuals, or accessories, please call the number shown below.

8 0 0 - 4 2 1 - 1 4 0 4

Please do not ship your product to Pioneer without first calling the Customer Support Division at the above listed number for assistance.

Pioneer Electronics (USA) Inc.
Customer Support Division
P.O. BOX 1760, Long Beach,
CA 90801-1760, U.S.A.

For warranty information please see the Limited Warranty sheet included with your product.

Should this product require service in Canada, please contact a Pioneer Canadian Authorized Dealer to locate the nearest Pioneer Authorized Service Company in Canada.

Alternatively, please contact the Customer Satisfaction Department at the following address:

Pioneer Electronics of Canada, Inc.
Customer Satisfaction Department
300 Allstate Parkway, Markham, Ontario L3R OP2
(905)479-4411
1(877)283-5901

For warranty information please see the Limited Warranty sheet included with your product.

Si ce produit doit être réparé au Canada, veuillez vous adresser à un distributeur autorisé Pioneer du Canada pour obtenir le nom du Centre de Service Autorisé Pioneer le plus près de chez-vous. Vous pouvez aussi contacter le Service à la clientèle de Pioneer:

Pioneer Electroniques du Canada, Inc.
Service à la clientèle
300, Allstate Parkway, Markham, Ontario L3R OP2
(905)479-4411
1(877)283-5901

Pour obtenir des renseignements sur la garantie, veuillez vous reporter au feuillet sur la garantie restreinte qui accompagne le produit.

S018D_enfr

PIONEER CORPORATION

4-1, Meguro 1-Chome, Meguro-ku, Tokyo 153-8654, Japan

PIONEER ELECTRONICS (USA) INC.

P.O. BOX 1540, Long Beach, California 90810-1540, U.S.A. TEL: (800) 421-1404

PIONEER ELECTRONICS OF CANADA, INC.

300 Allstate Parkway, Markham, Ontario L3R OP2, Canada TEL: (905) 479-4411

PIONEER EUROPE NV

Haven 1087, Keetberglaan 1, B-9120 Melsele, Belgium TEL: 03/570.05.11

PIONEER ELECTRONICS ASIACENTRE PTE. LTD.

253 Alexandra Road, #04-01, Singapore 159936 TEL: 656-472-1111

PIONEER ELECTRONICS AUSTRALIA PTY. LTD.

178-184 Boundary Road, Braeside, Victoria 3195, Australia, TEL: (03) 9586-6300

PIONEER ELECTRONICS DE MEXICO S.A. DE C.V.

Bldv.Manuel Avila Camacho 138 10 piso Col.Lomas de Chapultepec, Mexico,D.F. 11000 TEL: 55-9178-4270

K002E